

19 W. Daniels St. Apt. 1 Floor Plan

1st Floor

W. Daniels St., Cincinnati,
Ohio, United States 45219



Nazca Properties
manager@nazcaproperties.com
513-535-2154
2016-06-15

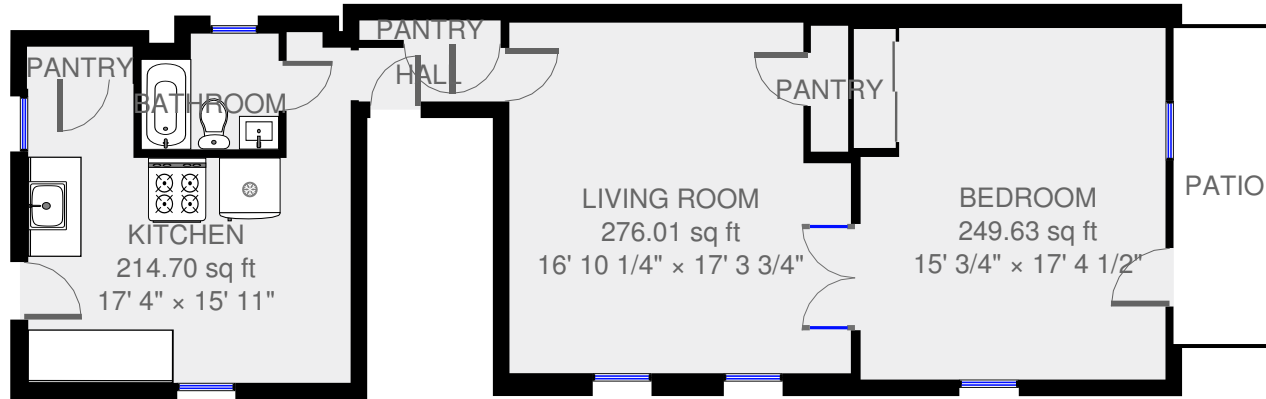

1 Floor

1 Bedroom

1 Bathroom



THIS FLOORPLAN IS PROVIDED WITHOUT WARRANTY OF ANY KIND. SENSOPIA DISCLAIMS ANY WARRANTY INCLUDING, WITHOUT LIMITATION, SATISFACTORY QUALITY OR ACCURACY OF DIMENSIONS.

Kitchen

Width: 15' 11"
 Length: 17' 4"
 Area: 214.70 sq ft
 Perimeter: 73' 10"
 Ceiling Height: 10' 4 1/4"

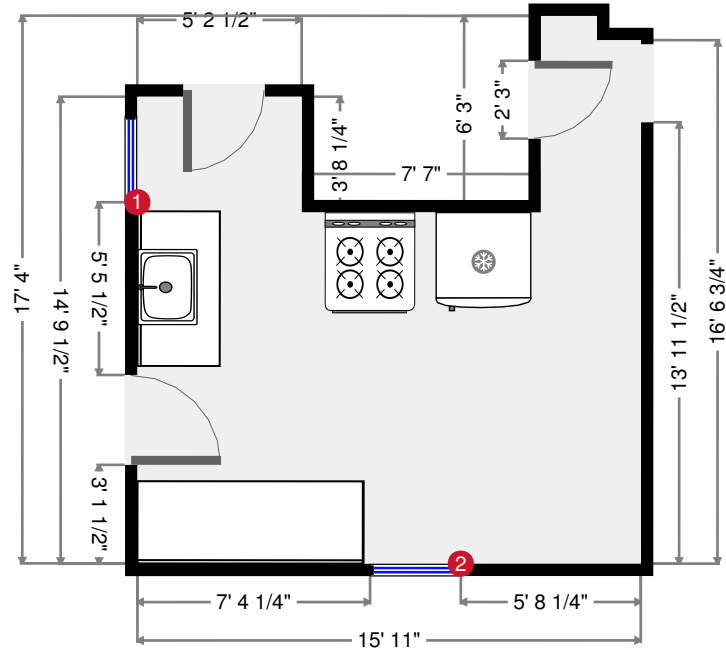

1



Hung Window

- Height: 6' 5"

2



Hung Window

- Height: 6' 11 1/4"

THIS FLOORPLAN IS PROVIDED WITHOUT WARRANTY OF ANY KIND. SENSOPIA DISCLAIMS ANY WARRANTY INCLUDING, WITHOUT LIMITATION, SATISFACTORY QUALITY OR ACCURACY OF DIMENSIONS.

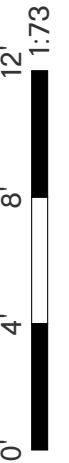

Pantry

Width: 2' 1 1/2"
Length: 5' 2 3/4"
Area: 10.85 sq ft
Perimeter: 14' 7 1/4"
Ceiling Height: 10' 4 1/4"



THIS FLOORPLAN IS PROVIDED WITHOUT WARRANTY OF ANY KIND. SENSOPIA DISCLAIMS ANY WARRANTY INCLUDING, WITHOUT LIMITATION, SATISFACTORY QUALITY OR ACCURACY OF DIMENSIONS.

Bathroom

Width: 5' 8 1/2"
 Length: 6' 9 1/2"
 Area: 35.72 sq ft
 Perimeter: 25' 1/4"
 Ceiling Height: 10' 4 1/4"

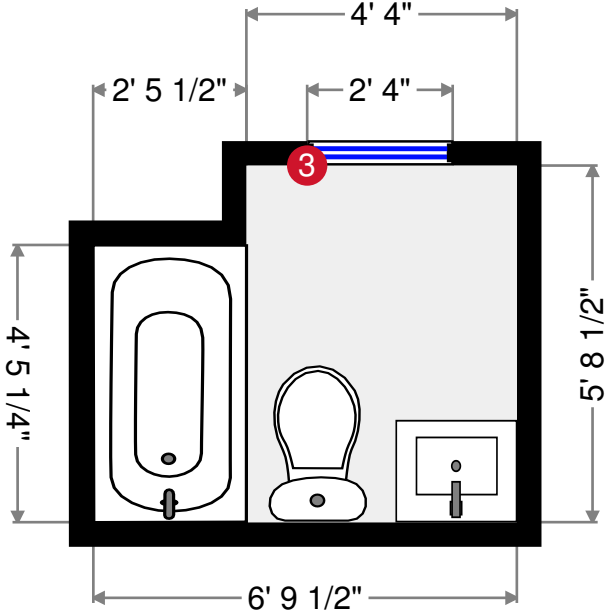

3



Hung Window

- Height: 2' 6 1/4"

THIS FLOORPLAN IS PROVIDED WITHOUT WARRANTY OF ANY KIND. SENSOPIA DISCLAIMS ANY WARRANTY INCLUDING, WITHOUT LIMITATION, SATISFACTORY QUALITY OR ACCURACY OF DIMENSIONS.



Hall

Width: 2' 7 3/4"
 Length: 7' 1/2"
 Area: 18.60 sq ft
 Perimeter: 19' 4 1/4"
 Ceiling Height: 10' 4 1/4"

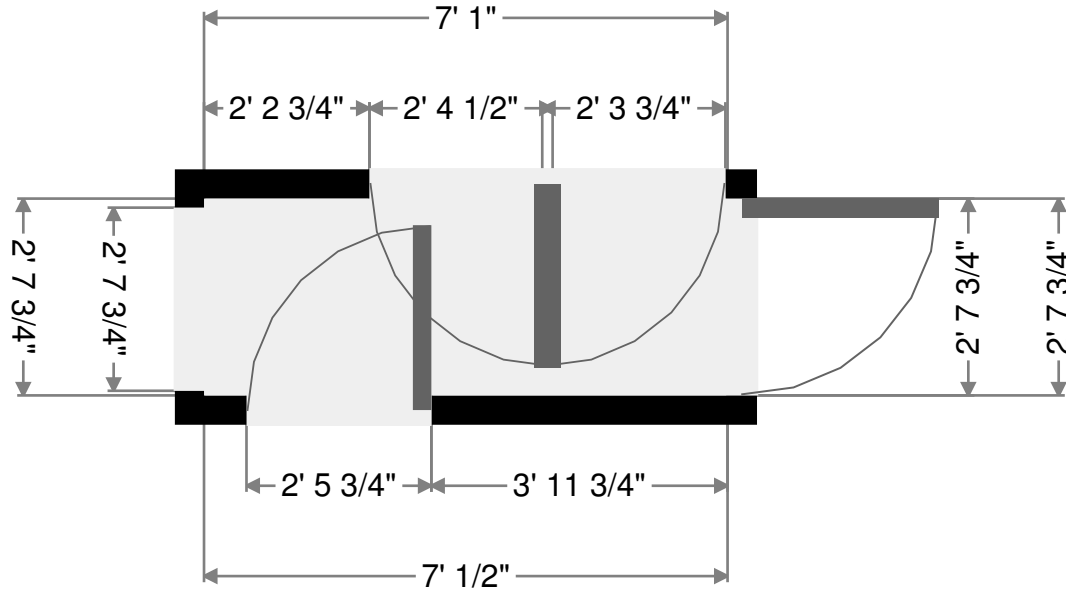

Pantry

Width: 11 3/4"
 Length: 6' 11 1/2"
 Area: 6.72 sq ft
 Perimeter: 15' 10 1/2"
 Ceiling Height: 10' 4 1/4"

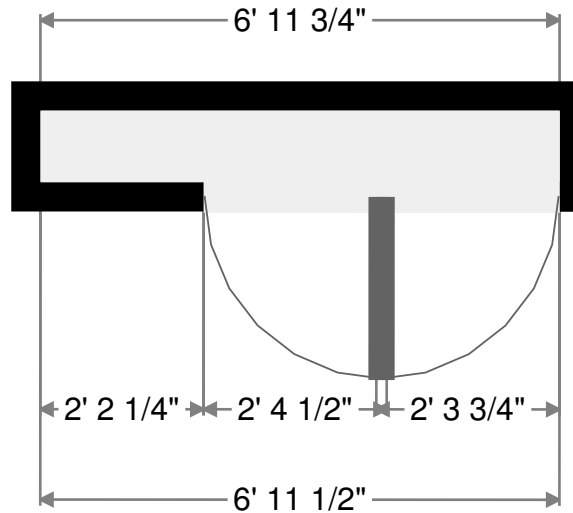

THIS FLOORPLAN IS PROVIDED WITHOUT WARRANTY OF ANY KIND. SENSOPIA DISCLAIMS ANY WARRANTY INCLUDING, WITHOUT LIMITATION, SATISFACTORY QUALITY OR ACCURACY OF DIMENSIONS.



Living Room

Width: 16' 10 1/4"
 Length: 17' 3 3/4"
 Area: 276.01 sq ft
 Perimeter: 68' 4 3/4"
 Ceiling Height: 10' 4 1/4"

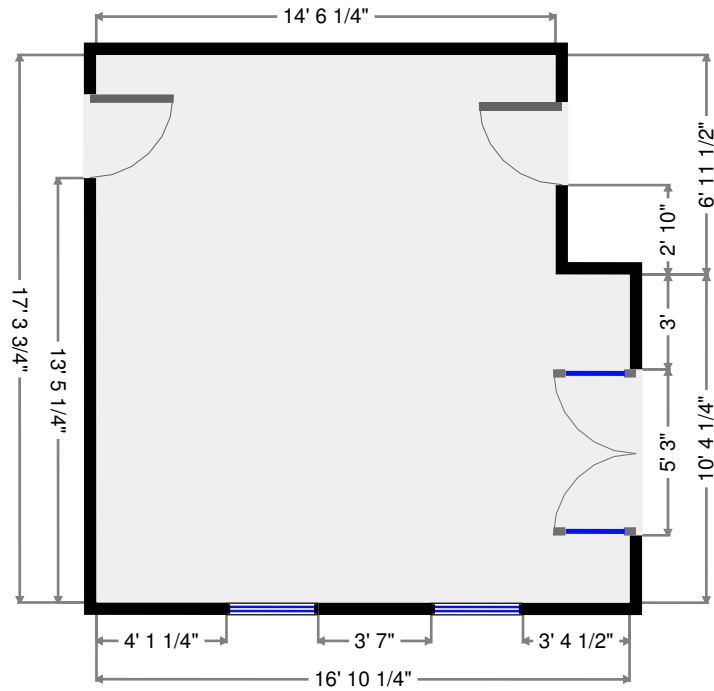
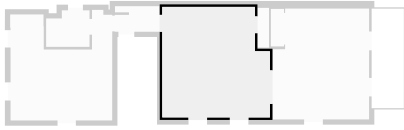

Pantry

Width: 1' 10 1/4"
 Length: 6' 2 3/4"
 Area: 11.46 sq ft
 Perimeter: 16' 1 1/2"
 Ceiling Height: 10' 4 1/4"

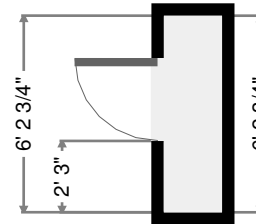

THIS FLOORPLAN IS PROVIDED WITHOUT WARRANTY OF ANY KIND. SENSOPIA DISCLAIMS ANY WARRANTY INCLUDING, WITHOUT LIMITATION, SATISFACTORY QUALITY OR ACCURACY OF DIMENSIONS.

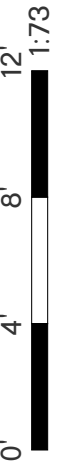

Bedroom

Width: 15' 3/4"
 Length: 17' 4 1/2"
 Area: 249.63 sq ft
 Perimeter: 64' 10 1/2"
 Ceiling Height: 10' 4 1/4"

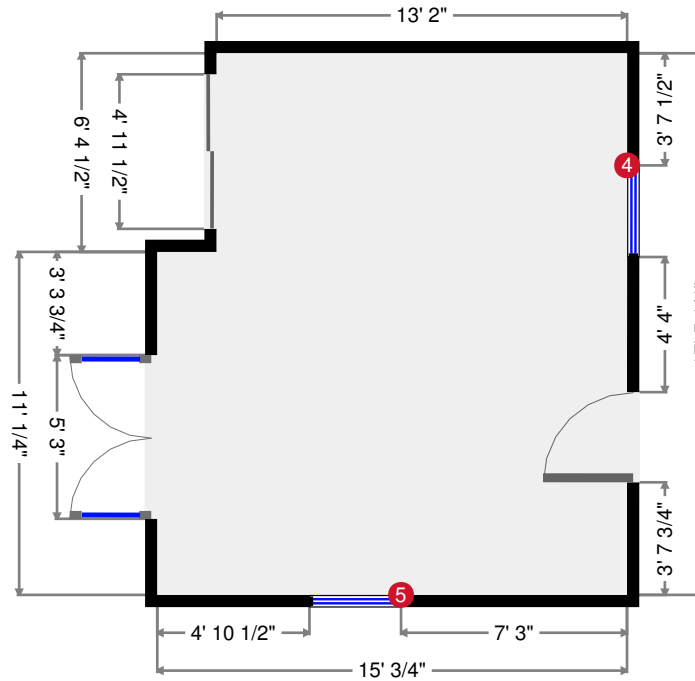

4



Hung Window

- Height: 6' 10"

5



Hung Window

- Height: 6' 10"

THIS FLOORPLAN IS PROVIDED WITHOUT WARRANTY OF ANY KIND. SENSOPIA DISCLAIMS ANY WARRANTY INCLUDING, WITHOUT LIMITATION, SATISFACTORY QUALITY OR ACCURACY OF DIMENSIONS.

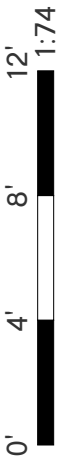

Pantry

Width: 2' 1 1/4"
Length: 5' 10 1/2"
Area: 12.16 sq ft
Perimeter: 15' 10 3/4"
Ceiling Height: 10' 4 1/4"

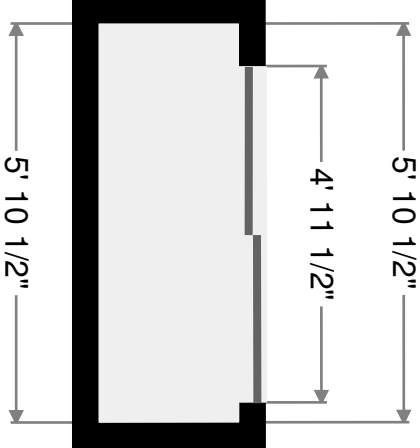

THIS FLOORPLAN IS PROVIDED WITHOUT WARRANTY OF ANY KIND. SENSOPIA DISCLAIMS ANY WARRANTY INCLUDING, WITHOUT LIMITATION, SATISFACTORY QUALITY OR ACCURACY OF DIMENSIONS.

Patio

Width: 5' 1/2"
Length: 15' 7 1/4"
Area: 78.82 sq ft
Perimeter: 41' 3 3/4"
Ceiling Height: 10' 4 1/4"

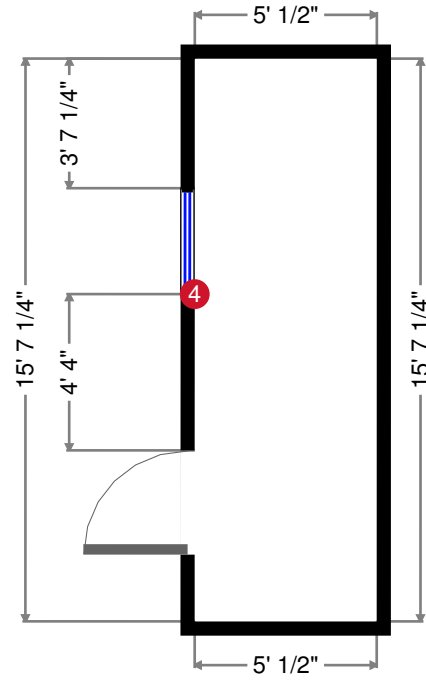

4



Hung Window

- Height: 6' 10"



THIS FLOORPLAN IS PROVIDED WITHOUT WARRANTY OF ANY KIND. SENSOPIA DISCLAIMS ANY WARRANTY INCLUDING, WITHOUT LIMITATION, SATISFACTORY QUALITY OR ACCURACY OF DIMENSIONS.