

20 W. Daniels St. Apt. 1



Nazca Properties
manager@nazcaproperties.com
513-535-2154

Statistics

Area: 610 sq ft
1 Floor
2 Bedrooms
1 Bathroom

1st Floor

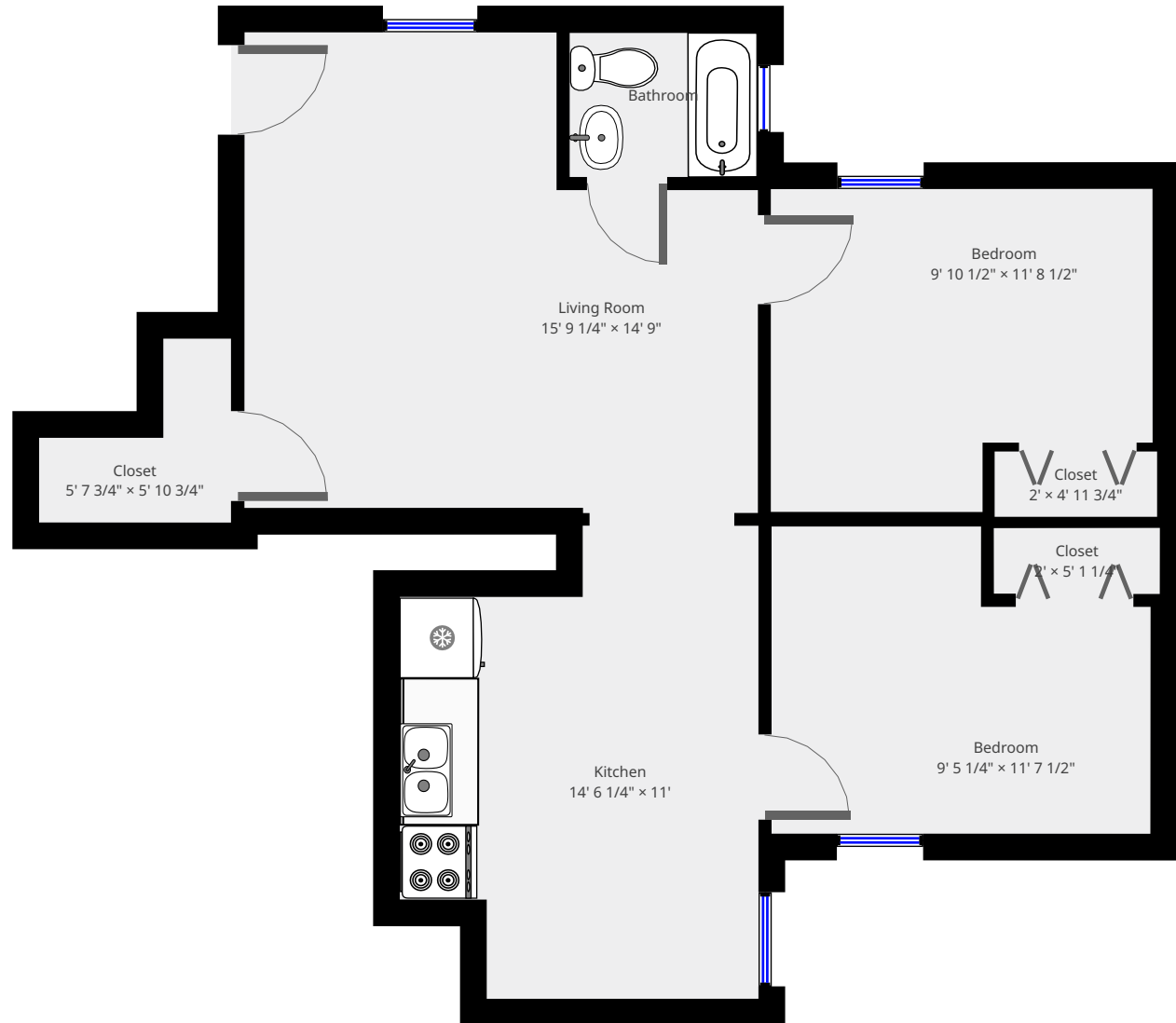

THIS FLOORPLAN IS PROVIDED WITHOUT WARRANTY OF ANY KIND. NAZCA PROPERTIES
DISCLAIMS ANY WARRANTY INCLUDING, WITHOUT LIMITATION, SATISFACTORY QUALITY OR
ACCURACY OF DIMENSIONS.

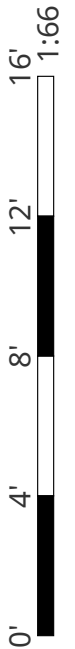

Living Room

Width: 14' 9"
Length: 15' 9 1/4"
Area: 201.02 sq ft
Perimeter: 61' 1/2"
Ceiling Height: 10' 6"

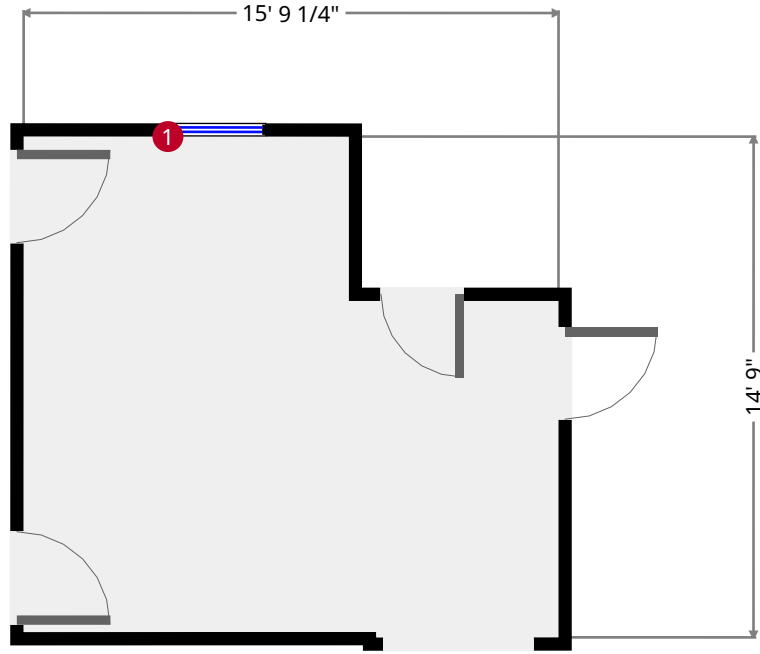
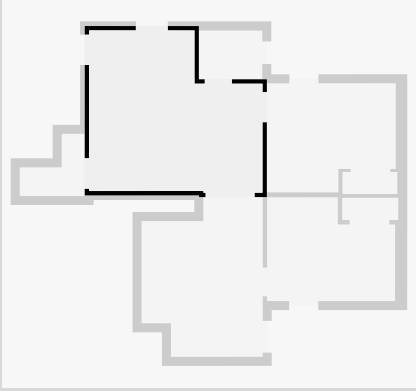

1



Hung Window

- Height: 5' 11 1/4"

THIS FLOORPLAN IS PROVIDED WITHOUT WARRANTY OF ANY KIND. NAZCA PROPERTIES
DISCLAIMS ANY WARRANTY INCLUDING, WITHOUT LIMITATION, SATISFACTORY QUALITY OR
ACCURACY OF DIMENSIONS.



Closet

Width: 5' 7 3/4"
Length: 5' 10 3/4"
Area: 21.64 sq ft
Perimeter: 23' 3/4"

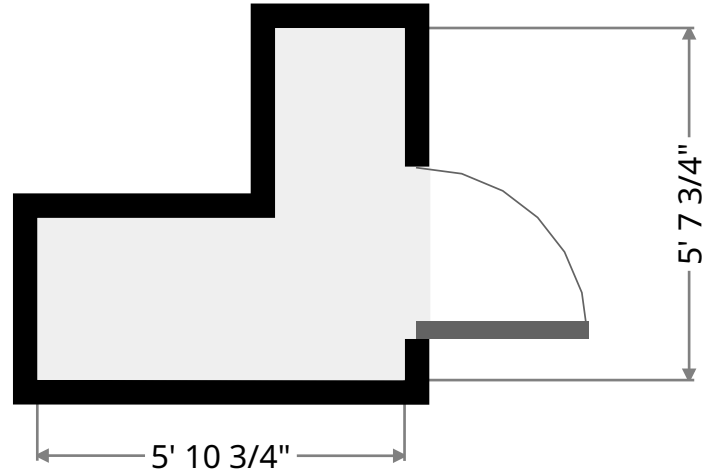
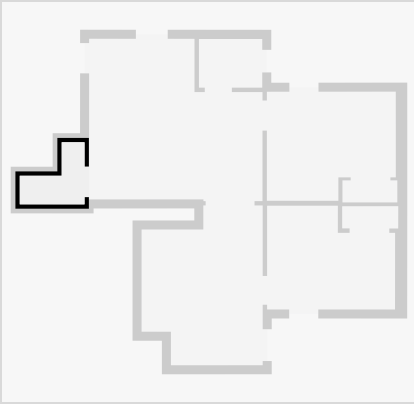

Bathroom

Width: 4' 5"
Length: 5' 9"
Area: 25.45 sq ft
Perimeter: 20' 4 1/4"
Ceiling Height: 8' 2 1/2"

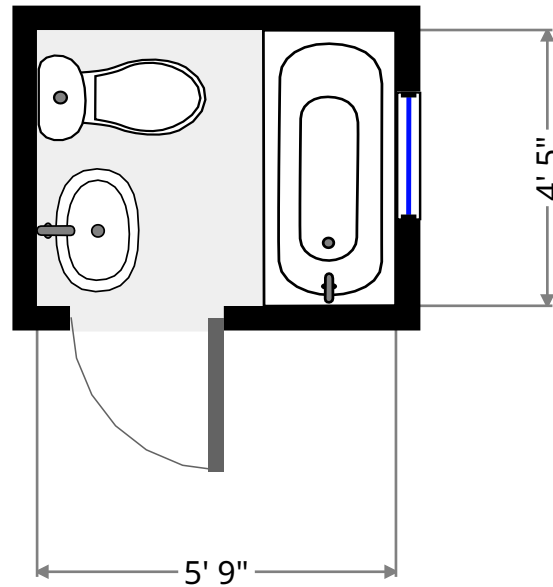
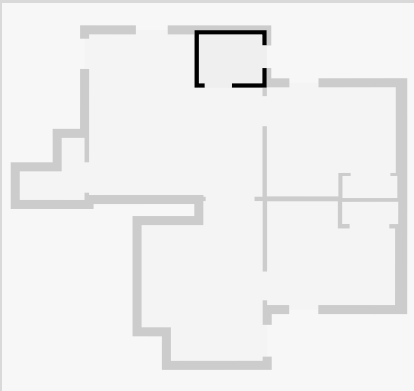

THIS FLOORPLAN IS PROVIDED WITHOUT WARRANTY OF ANY KIND. NAZCA PROPERTIES
DISCLAIMS ANY WARRANTY INCLUDING, WITHOUT LIMITATION, SATISFACTORY QUALITY OR
ACCURACY OF DIMENSIONS.



Bedroom

Width: 9' 10 1/2"
Length: 11' 8 1/2"
Area: 105.07 sq ft
Perimeter: 43' 3 1/4"
Ceiling Height: 8' 11 1/2"

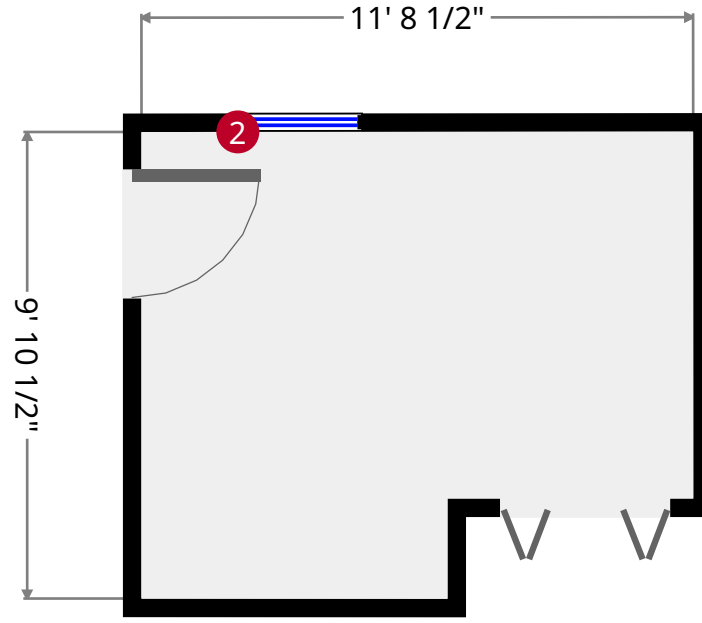
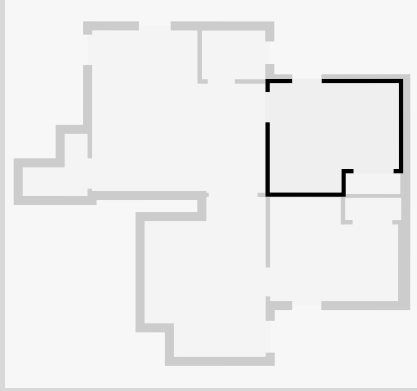

2



Hung Window

- Height: 5'

THIS FLOORPLAN IS PROVIDED WITHOUT WARRANTY OF ANY KIND. NAZCA PROPERTIES
DISCLAIMS ANY WARRANTY INCLUDING, WITHOUT LIMITATION, SATISFACTORY QUALITY OR
ACCURACY OF DIMENSIONS.

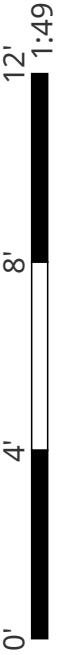

Closet

Width: 2'
Length: 4' 11 3/4"
Area: 10.00 sq ft
Perimeter: 13' 11 3/4"

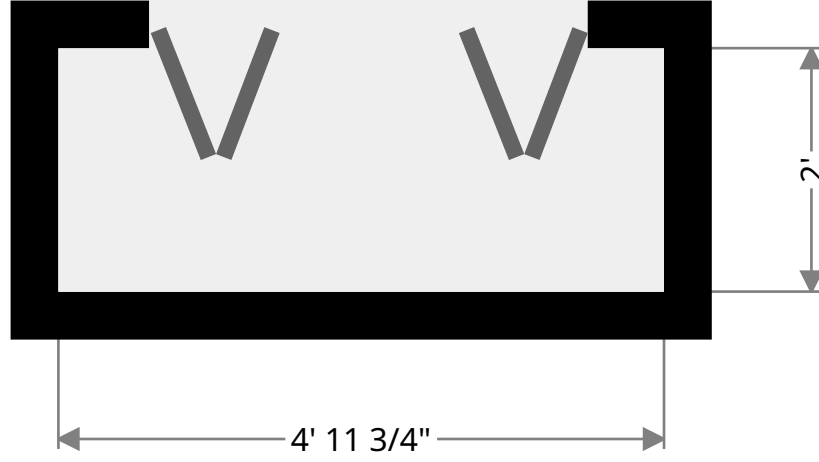
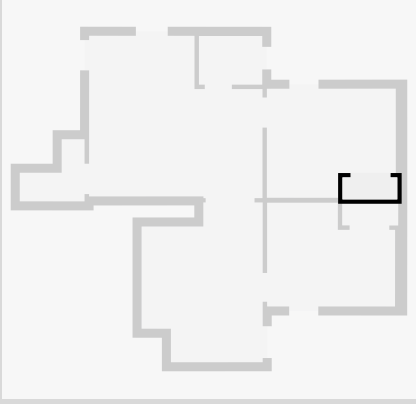

THIS FLOORPLAN IS PROVIDED WITHOUT WARRANTY OF ANY KIND. NAZCA PROPERTIES
DISCLAIMS ANY WARRANTY INCLUDING, WITHOUT LIMITATION, SATISFACTORY QUALITY OR
ACCURACY OF DIMENSIONS.

Kitchen

Width: 11'
Length: 14' 6 1/4"
Area: 139.50 sq ft
Perimeter: 51' 3/4"
Ceiling Height: 9' 8"

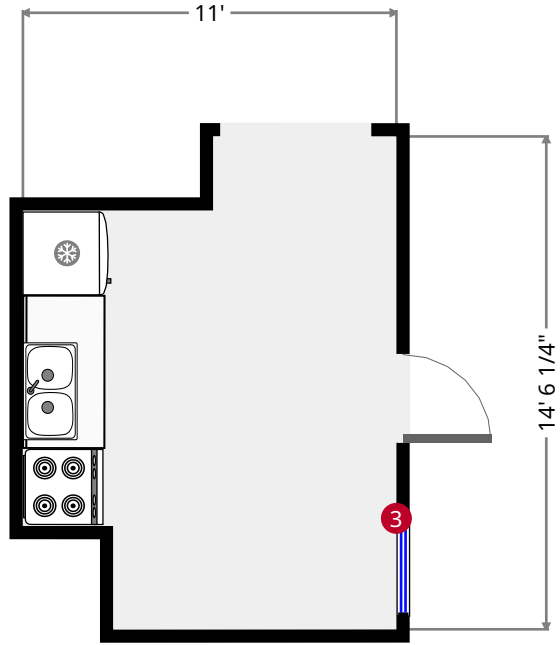
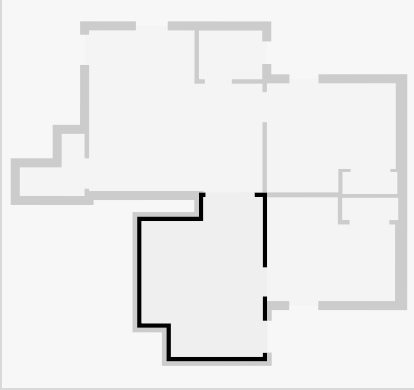

3



Hung Window

- Height: 5' 8 1/4"

THIS FLOORPLAN IS PROVIDED WITHOUT WARRANTY OF ANY KIND. NAZCA PROPERTIES
DISCLAIMS ANY WARRANTY INCLUDING, WITHOUT LIMITATION, SATISFACTORY QUALITY OR
ACCURACY OF DIMENSIONS.



Bedroom

Width: 9' 5 1/4"
Length: 11' 7 1/2"
Area: 96.89 sq ft
Perimeter: 42' 1 1/2"
Ceiling Height: 2' 7 1/2"

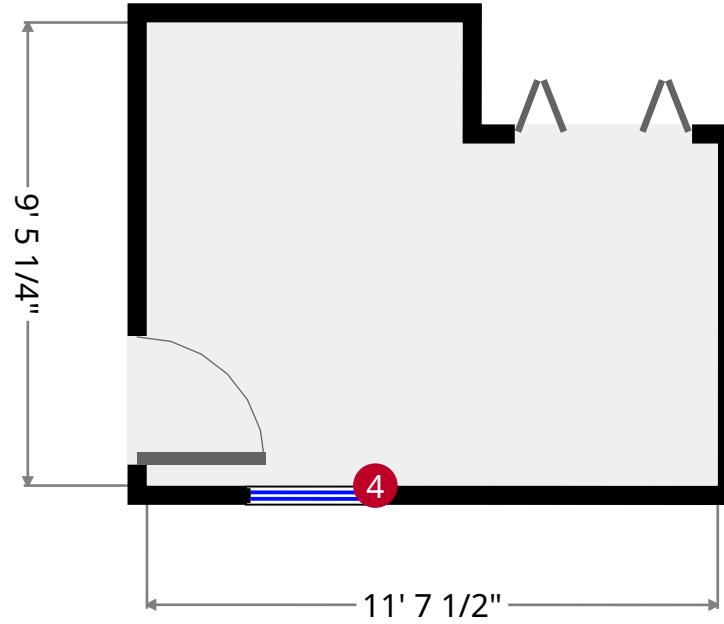
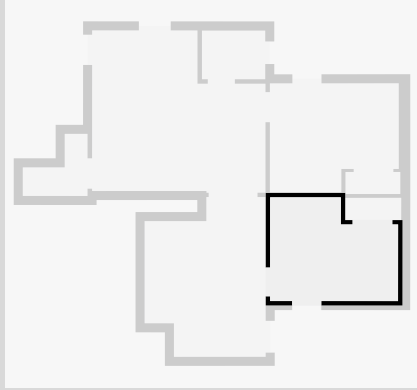

4



Hung Window

- Height: 5' 1/2"

THIS FLOORPLAN IS PROVIDED WITHOUT WARRANTY OF ANY KIND. NAZCA PROPERTIES
DISCLAIMS ANY WARRANTY INCLUDING, WITHOUT LIMITATION, SATISFACTORY QUALITY OR
ACCURACY OF DIMENSIONS.



Closet

Width: 2'
Length: 5' 1 1/4"
Area: 10.29 sq ft
Perimeter: 14' 2 3/4"

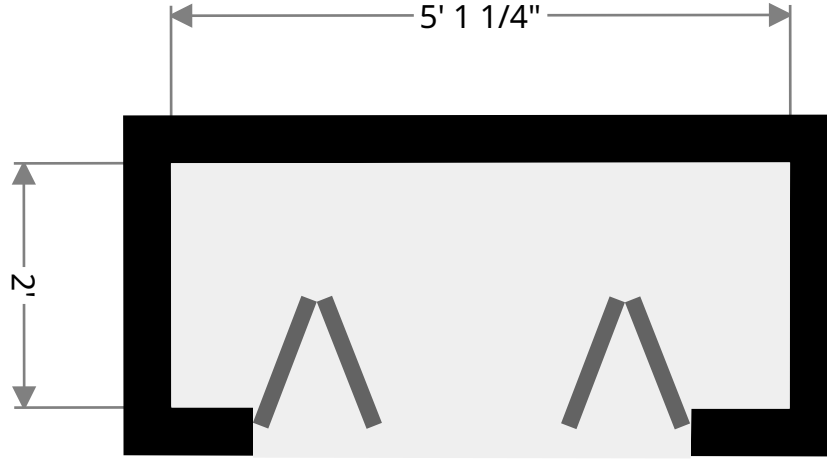
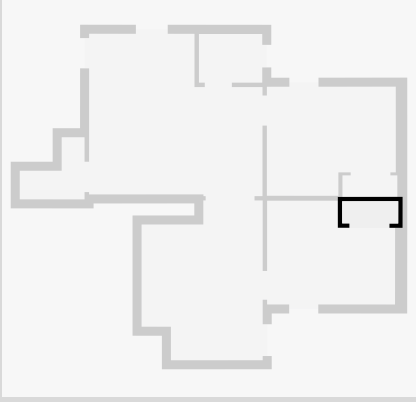

THIS FLOORPLAN IS PROVIDED WITHOUT WARRANTY OF ANY KIND. NAZCA PROPERTIES
DISCLAIMS ANY WARRANTY INCLUDING, WITHOUT LIMITATION, SATISFACTORY QUALITY OR
ACCURACY OF DIMENSIONS.