

221 Renner St. Apt. 2

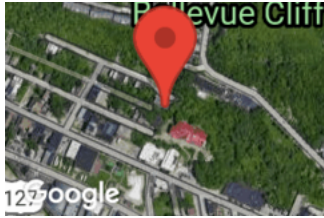

221 Renner Street, Cincinnati, Ohio, USA 45214



Nazca Properties
manager@nazcaproperties.com
513-535-2154

Statistics

Area: 1221 sq ft
1 Floor
2 Bedrooms
2 Bathrooms

Ground Floor

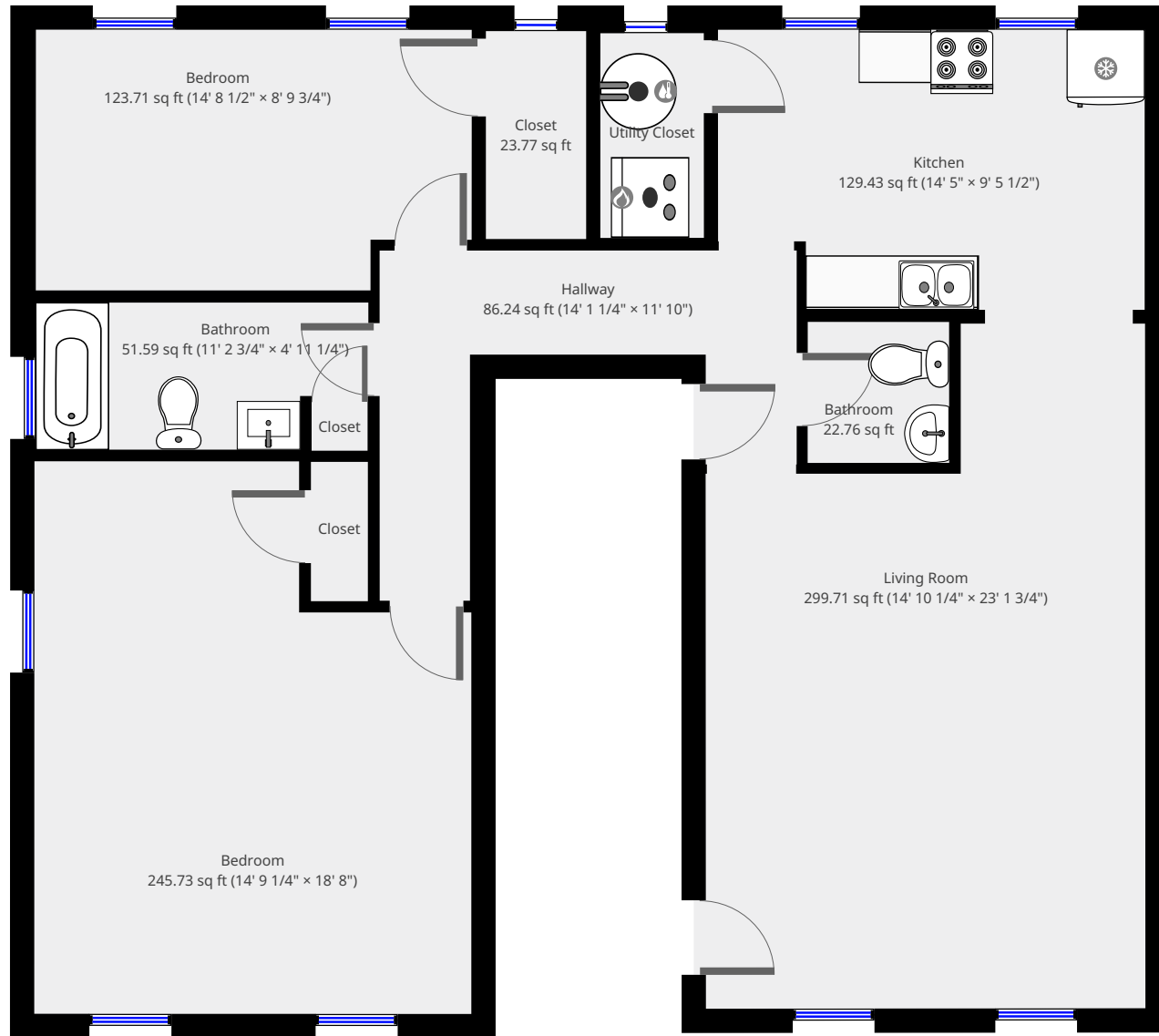

THIS FLOORPLAN IS PROVIDED WITHOUT WARRANTY OF ANY KIND. NAZCA PROPERTIES
DISCLAIMS ANY WARRANTY INCLUDING, WITHOUT LIMITATION, SATISFACTORY QUALITY OR
ACCURACY OF DIMENSIONS.



Living Room

Width: 14' 10 1/4"
Length: 23' 1 3/4"
Area: 299.71 sq ft
Perimeter: 75' 11 1/2"
Ceiling Height: 9' 2 1/4"

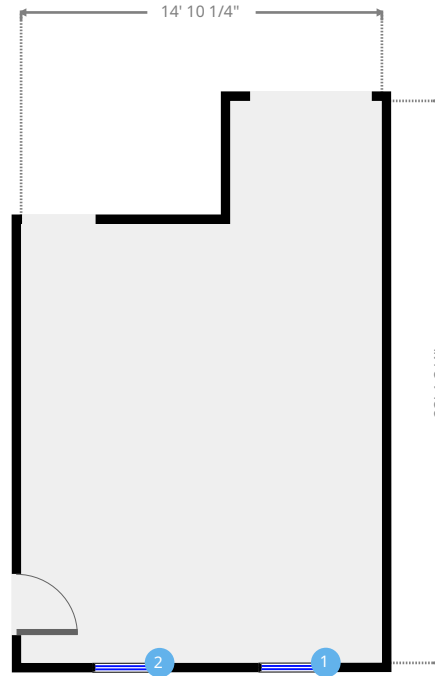
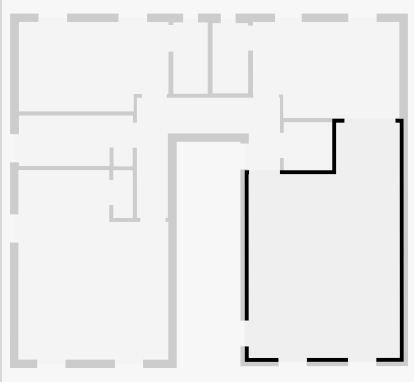

1



Hung Window

- Height: 6' 1 1/2"

2



Hung Window

- Height: 6' 1 1/2"

THIS FLOORPLAN IS PROVIDED WITHOUT WARRANTY OF ANY KIND. NAZCA PROPERTIES
DISCLAIMS ANY WARRANTY INCLUDING, WITHOUT LIMITATION, SATISFACTORY QUALITY OR
ACCURACY OF DIMENSIONS.

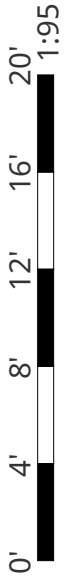

Kitchen

Width: 9' 5 1/2"
 Length: 14' 5"
 Area: 129.43 sq ft
 Perimeter: 47' 8 3/4"
 Ceiling Height: 9' 3 1/4"

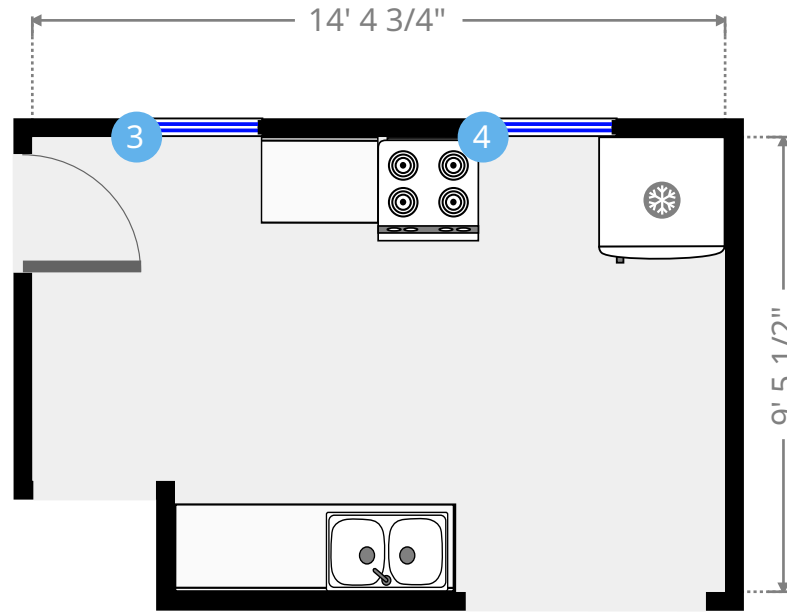
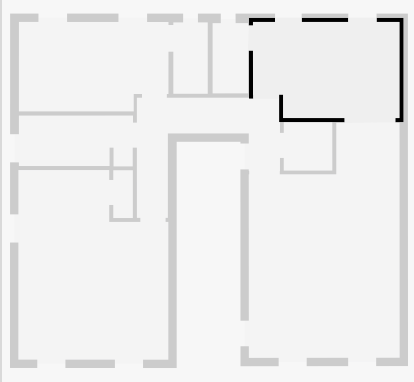

3



Hung Window

- Height: 5' 11 1/2"

4



Hung Window

- Height: 5' 11 1/2"

THIS FLOORPLAN IS PROVIDED WITHOUT WARRANTY OF ANY KIND. NAZCA PROPERTIES
 DISCLAIMS ANY WARRANTY INCLUDING, WITHOUT LIMITATION, SATISFACTORY QUALITY OR
 ACCURACY OF DIMENSIONS.



Utility Closet

Width: 3' 6"
Length: 6' 11"
Area: 24.17 sq ft
Perimeter: 20' 9 3/4"
Ceiling Height: 9' 2 1/4"

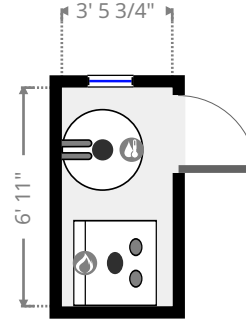
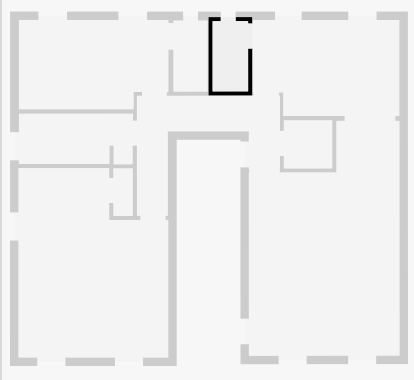

Hallway

Width: 11' 10"
Length: 14' 1 1/4"
Area: 86.24 sq ft
Perimeter: 59' 2 3/4"
Ceiling Height: 7' 6"

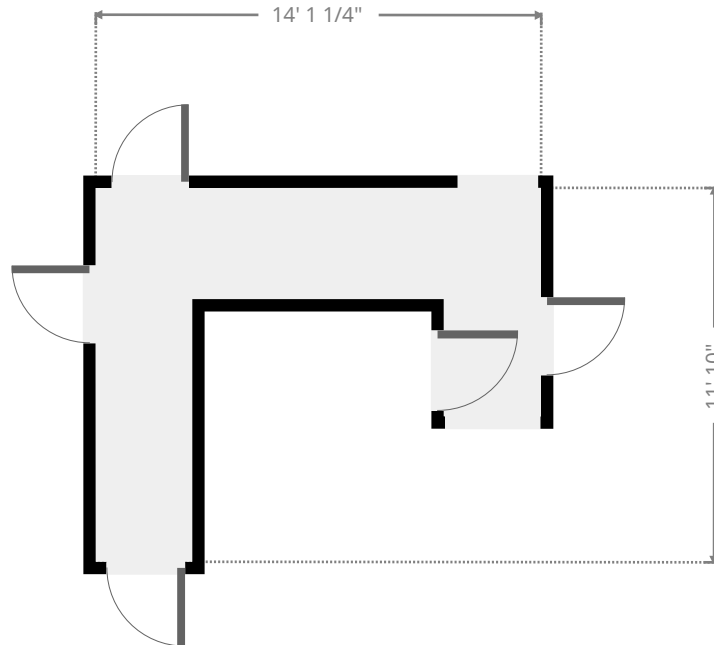
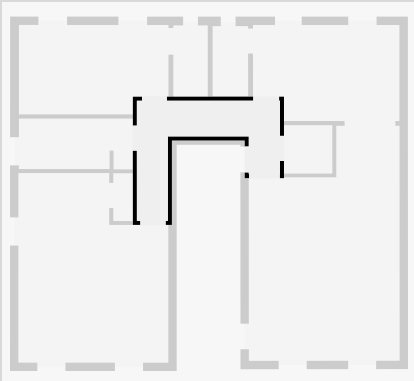

THIS FLOORPLAN IS PROVIDED WITHOUT WARRANTY OF ANY KIND. NAZCA PROPERTIES
DISCLAIMS ANY WARRANTY INCLUDING, WITHOUT LIMITATION, SATISFACTORY QUALITY OR
ACCURACY OF DIMENSIONS.

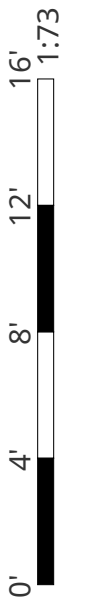

Bathroom

Width: 4' 9 1/4"
Length: 4' 9 1/2"
Area: 22.76 sq ft
Perimeter: 19' 1"
Ceiling Height: 7' 11"

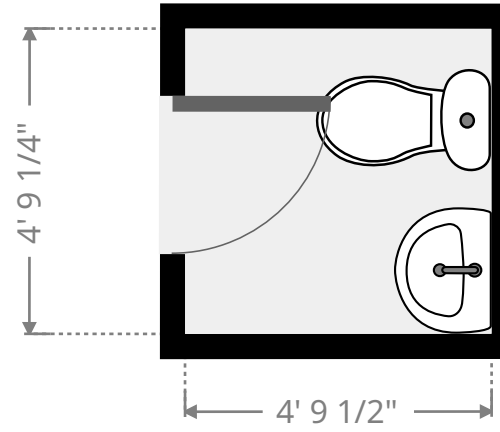
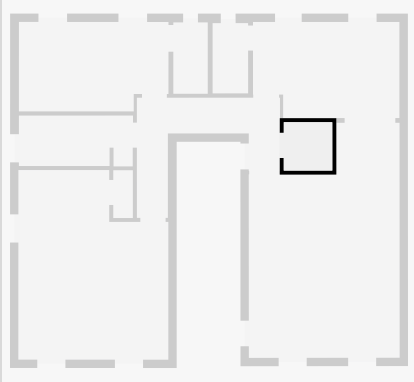

Closet

Width: 3' 4 3/4"
Length: 7' 1/4"
Area: 23.77 sq ft
Perimeter: 20' 9 3/4"
Ceiling Height: 9' 2 1/4"

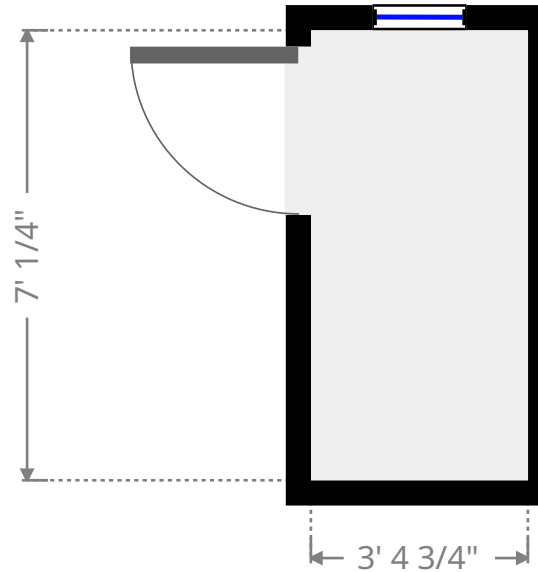
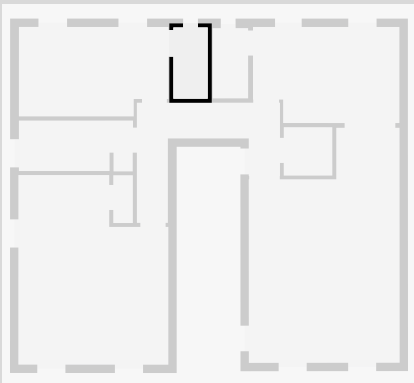

THIS FLOORPLAN IS PROVIDED WITHOUT WARRANTY OF ANY KIND. NAZCA PROPERTIES
DISCLAIMS ANY WARRANTY INCLUDING, WITHOUT LIMITATION, SATISFACTORY QUALITY OR
ACCURACY OF DIMENSIONS.



Bedroom

Width: 8' 9 3/4"
Length: 14' 8 1/2"
Area: 123.71 sq ft
Perimeter: 47' 1/2"
Ceiling Height: 8' 9 1/4"

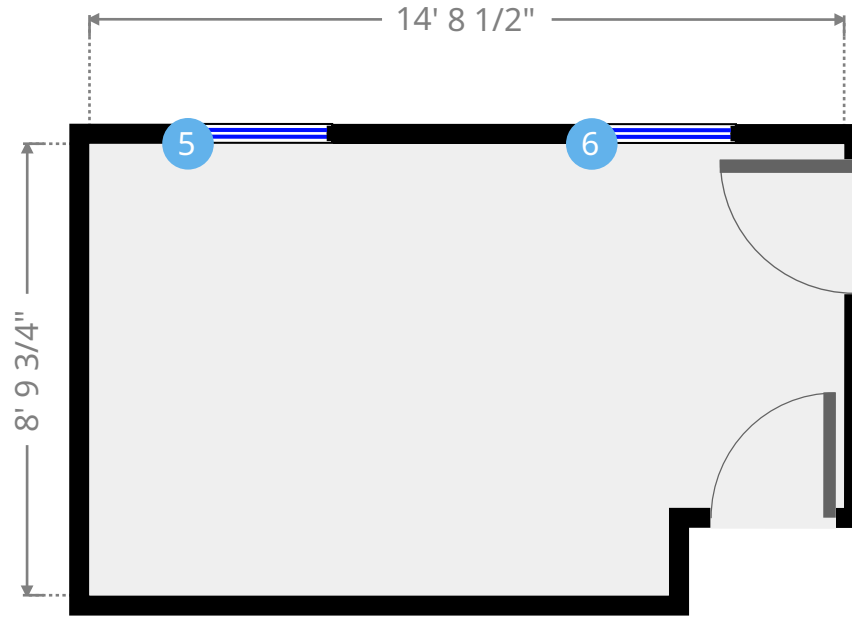
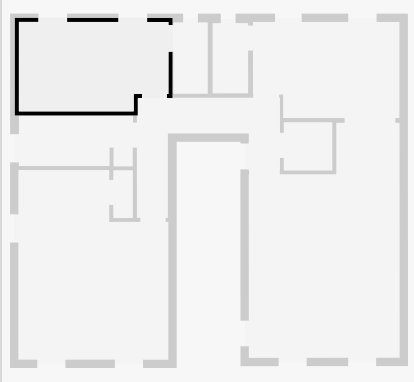

5



Hung Window

- Height: 6' 1 1/4"

6



Hung Window

- Height: 6' 1 1/4"

THIS FLOORPLAN IS PROVIDED WITHOUT WARRANTY OF ANY KIND. NAZCA PROPERTIES
DISCLAIMS ANY WARRANTY INCLUDING, WITHOUT LIMITATION, SATISFACTORY QUALITY OR
ACCURACY OF DIMENSIONS.



Bathroom

Width: 4' 11 1/4"
Length: 11' 2 3/4"
Area: 51.59 sq ft
Perimeter: 32' 4 3/4"
Ceiling Height: 9' 1 3/4"

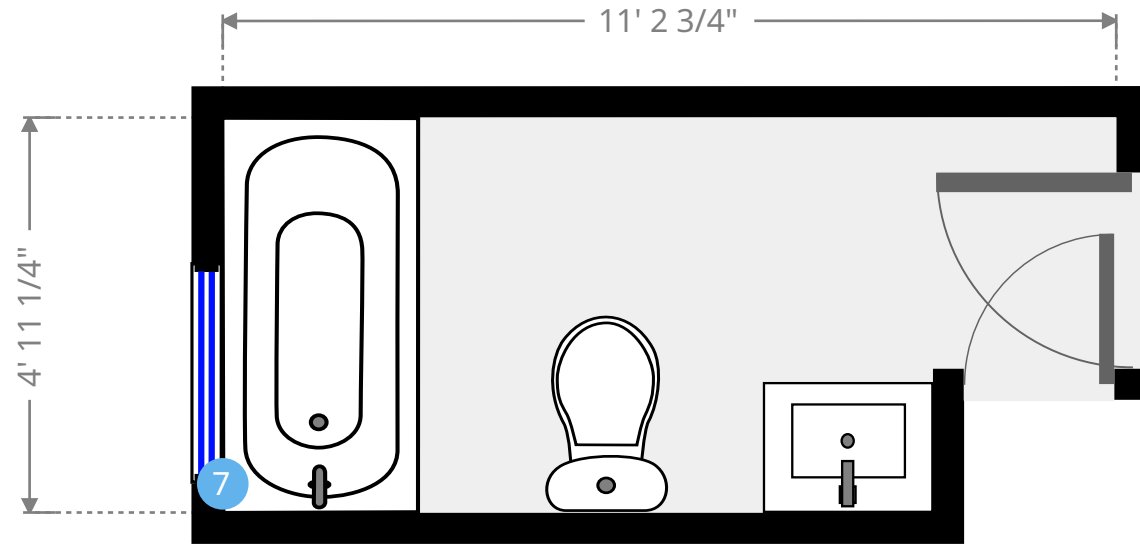
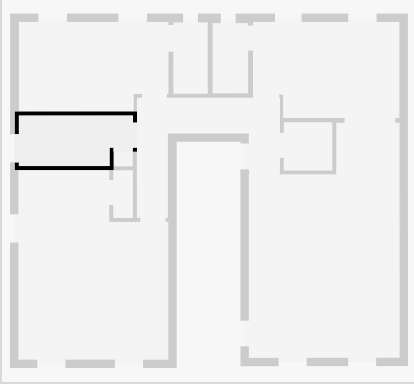

7



Hung Window

- Height: 3' 10"

THIS FLOORPLAN IS PROVIDED WITHOUT WARRANTY OF ANY KIND. NAZCA PROPERTIES
DISCLAIMS ANY WARRANTY INCLUDING, WITHOUT LIMITATION, SATISFACTORY QUALITY OR
ACCURACY OF DIMENSIONS.

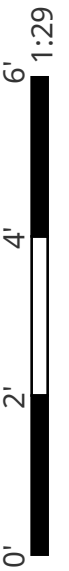

Closet

Width: 1' 4 3/4"
Length: 1' 10 3/4"
Area: 2.65 sq ft
Perimeter: 6' 7"
Ceiling Height: 9' 2 1/4"

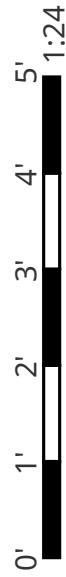
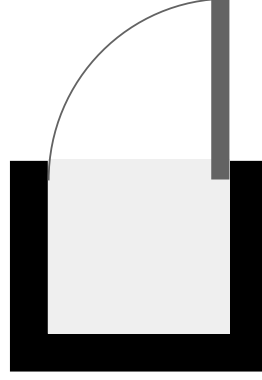
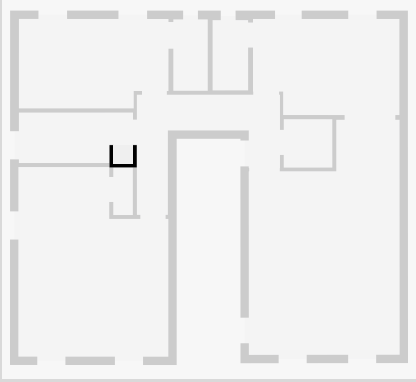

THIS FLOORPLAN IS PROVIDED WITHOUT WARRANTY OF ANY KIND. NAZCA PROPERTIES
DISCLAIMS ANY WARRANTY INCLUDING, WITHOUT LIMITATION, SATISFACTORY QUALITY OR
ACCURACY OF DIMENSIONS.

Bedroom

Width: 14' 9 1/4"
 Length: 18' 8"
 Area: 245.73 sq ft
 Perimeter: 66' 10"
 Ceiling Height: 9' 3 1/2"

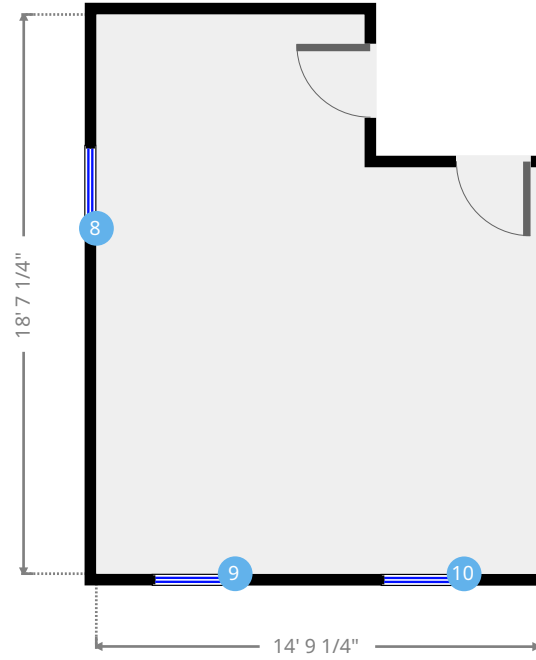
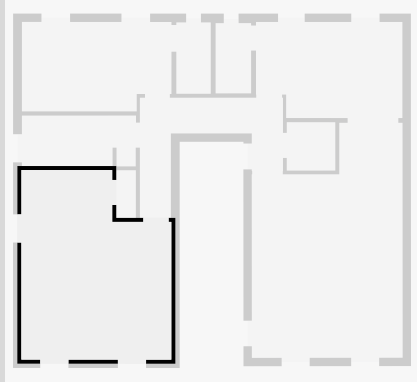

8



Hung Window

- Height: 5' 8"

9



Hung Window

- Height: 5' 8"

10



Hung Window

- Height: 5' 8"

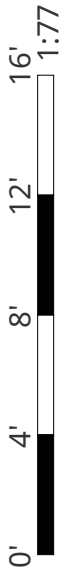

THIS FLOORPLAN IS PROVIDED WITHOUT WARRANTY OF ANY KIND. NAZCA PROPERTIES
 DISCLAIMS ANY WARRANTY INCLUDING, WITHOUT LIMITATION, SATISFACTORY QUALITY OR
 ACCURACY OF DIMENSIONS.

Closet

Width: 1' 11"
Length: 4' 8 1/2"
Area: 9.05 sq ft
Perimeter: 13' 3"
Ceiling Height: 9' 2 1/4"

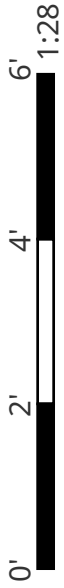
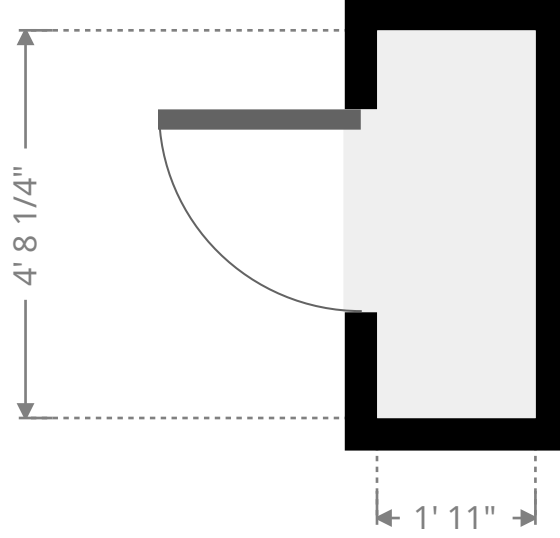
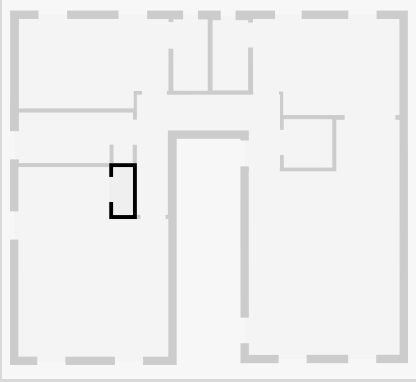

THIS FLOORPLAN IS PROVIDED WITHOUT WARRANTY OF ANY KIND. NAZCA PROPERTIES
DISCLAIMS ANY WARRANTY INCLUDING, WITHOUT LIMITATION, SATISFACTORY QUALITY OR
ACCURACY OF DIMENSIONS.