

221 Renner St. Apt. 3



221 Renner Street, Cincinnati, Ohio, USA 45214



Nazca Properties
manager@nazcaproperties.com
513-535-2154

Statistics

Area: 1213 sq ft
1 Floor
3 Bedrooms
2 Bathrooms

2nd Floor

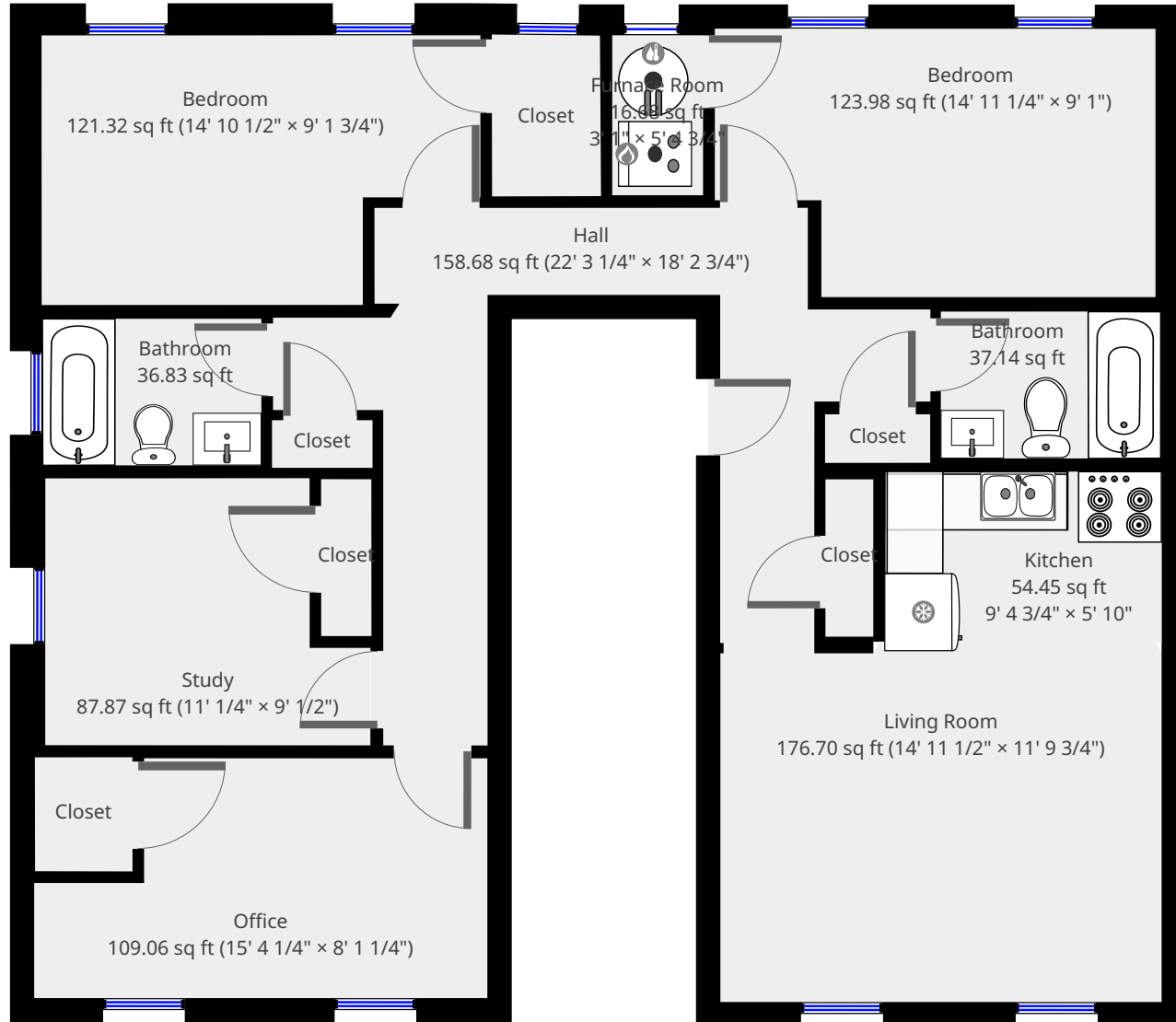

THIS FLOORPLAN IS PROVIDED WITHOUT WARRANTY OF ANY KIND. NAZCA PROPERTIES
DISCLAIMS ANY WARRANTY INCLUDING, WITHOUT LIMITATION, SATISFACTORY QUALITY OR
ACCURACY OF DIMENSIONS.



Kitchen

Width: 5' 10"
Length: 9' 4 3/4"
Area: 54.45 sq ft
Perimeter: 30' 4 1/2"
Ceiling Height: 8' 10 1/2"

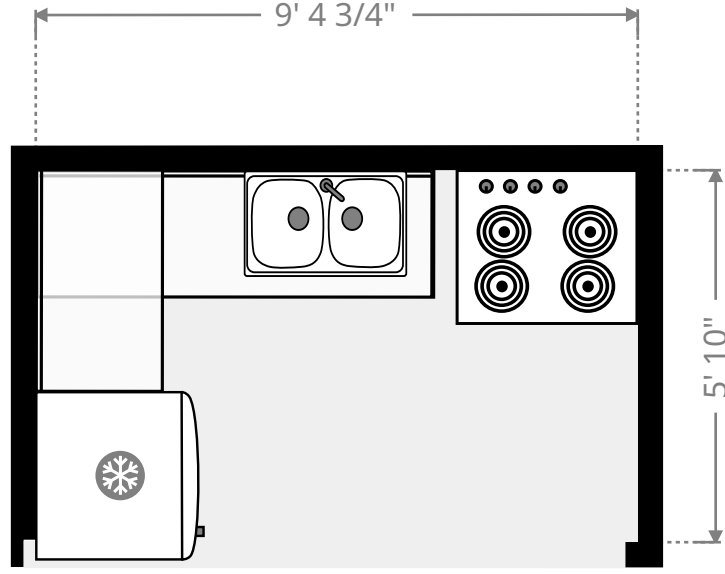
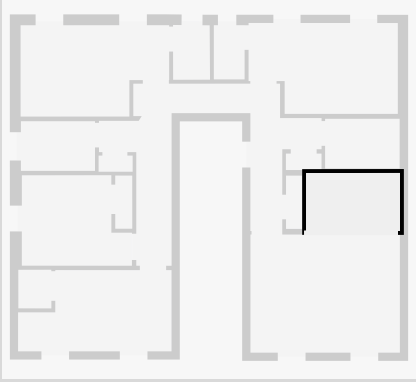

THIS FLOORPLAN IS PROVIDED WITHOUT WARRANTY OF ANY KIND. NAZCA PROPERTIES
DISCLAIMS ANY WARRANTY INCLUDING, WITHOUT LIMITATION, SATISFACTORY QUALITY OR
ACCURACY OF DIMENSIONS.

Living Room

Width: 11' 9 3/4"
 Length: 14' 11 1/2"
 Area: 176.70 sq ft
 Perimeter: 53' 6 1/2"
 Ceiling Height: 8' 10 1/2"

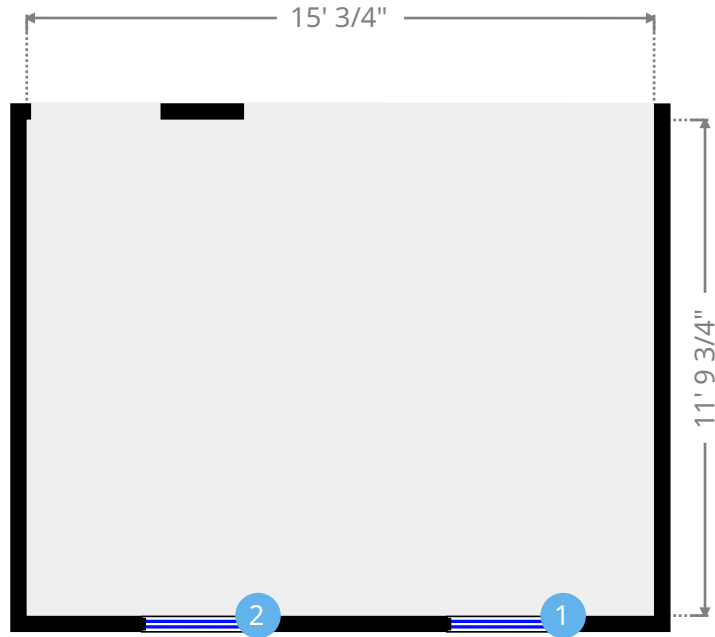
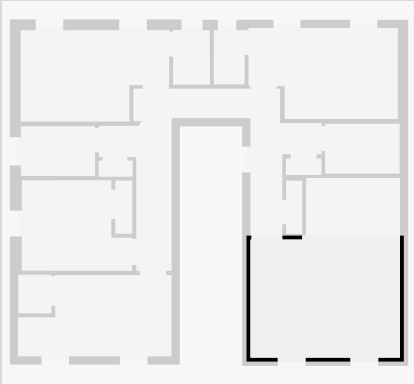

1



Hung Window

- Height: 5' 4 1/2"

2



Hung Window

- Height: 5' 4 1/2"

THIS FLOORPLAN IS PROVIDED WITHOUT WARRANTY OF ANY KIND. NAZCA PROPERTIES
 DISCLAIMS ANY WARRANTY INCLUDING, WITHOUT LIMITATION, SATISFACTORY QUALITY OR
 ACCURACY OF DIMENSIONS.

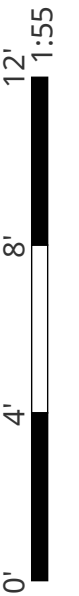

Hall

Width: 18' 2 3/4"
Length: 22' 3 1/4"
Area: 158.68 sq ft
Perimeter: 106' 3/4"
Ceiling Height: 8' 10 1/2"

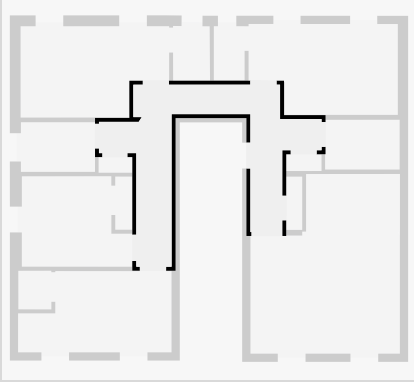

Closet

Width: 1' 7 1/2"
Length: 5' 4"
Area: 8.65 sq ft
Perimeter: 13' 11"
Ceiling Height: 8' 10 1/2"

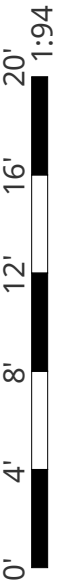
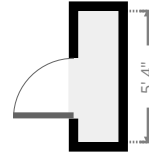
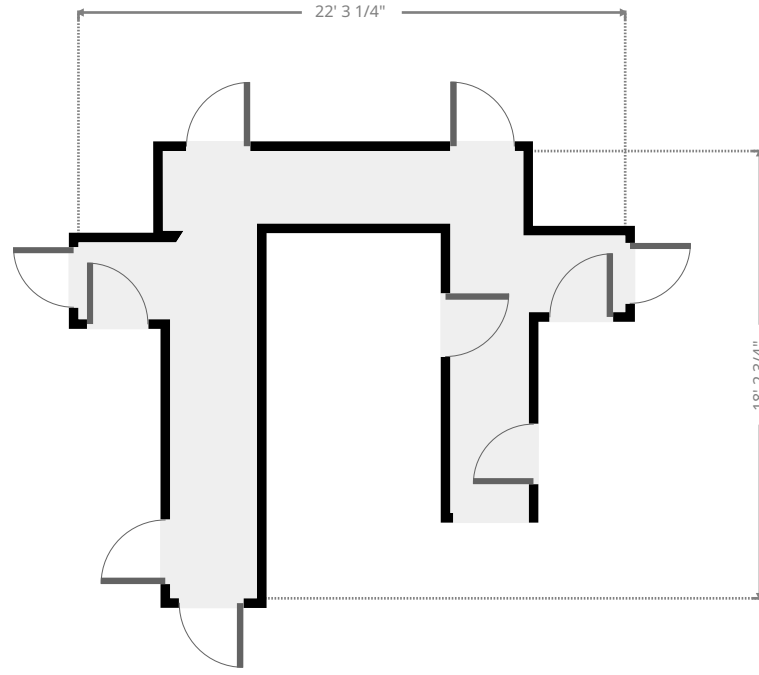
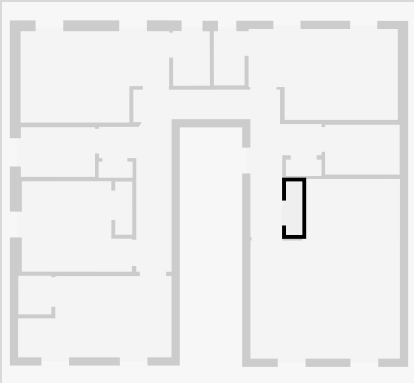

THIS FLOORPLAN IS PROVIDED WITHOUT WARRANTY OF ANY KIND. NAZCA PROPERTIES
DISCLAIMS ANY WARRANTY INCLUDING, WITHOUT LIMITATION, SATISFACTORY QUALITY OR
ACCURACY OF DIMENSIONS.

Closet

Width: 1' 7 3/4"
Length: 3' 6 3/4"
Area: 5.86 sq ft
Perimeter: 10' 5"
Ceiling Height: 8' 10 1/2"

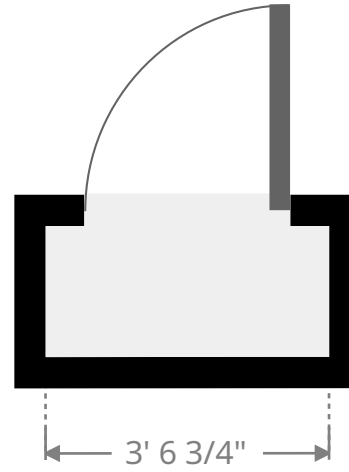
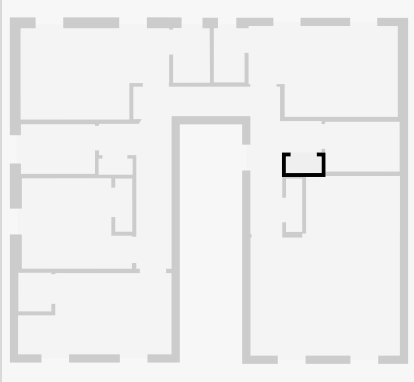

Bathroom

Width: 4' 11 3/4"
Length: 7' 5 1/2"
Area: 37.14 sq ft
Perimeter: 24' 10 1/2"
Ceiling Height: 8' 10 1/2"

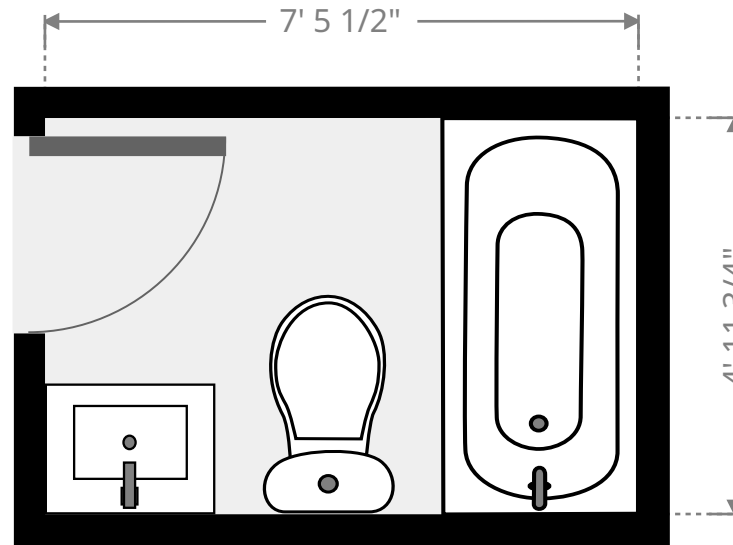
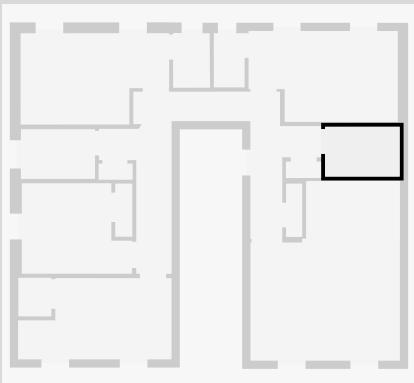

THIS FLOORPLAN IS PROVIDED WITHOUT WARRANTY OF ANY KIND. NAZCA PROPERTIES
DISCLAIMS ANY WARRANTY INCLUDING, WITHOUT LIMITATION, SATISFACTORY QUALITY OR
ACCURACY OF DIMENSIONS.

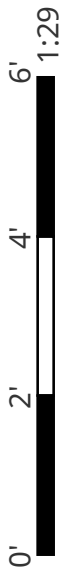

Bedroom

Width: 9' 1"
Length: 14' 11 1/4"
Area: 123.98 sq ft
Perimeter: 48' 3/4"
Ceiling Height: 8' 10 1/2"

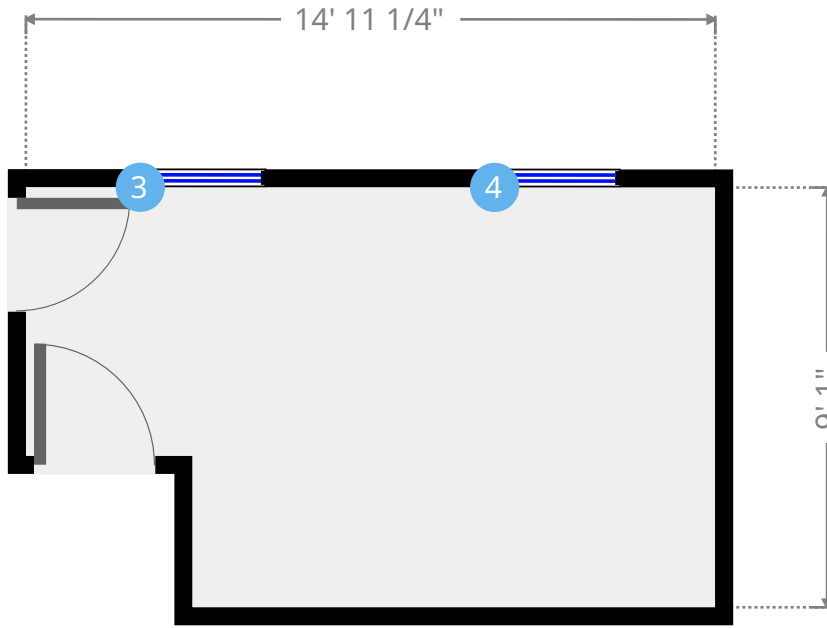
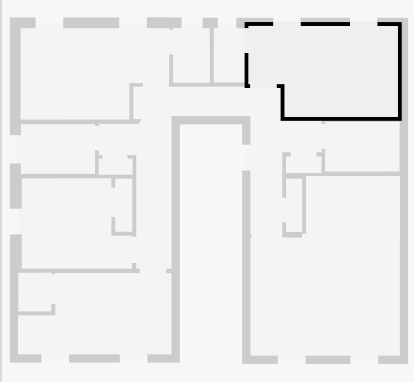

3



Hung Window

- Height: 5' 3 3/4"

4



Hung Window

- Height: 5' 3 3/4"

THIS FLOORPLAN IS PROVIDED WITHOUT WARRANTY OF ANY KIND. NAZCA PROPERTIES
DISCLAIMS ANY WARRANTY INCLUDING, WITHOUT LIMITATION, SATISFACTORY QUALITY OR
ACCURACY OF DIMENSIONS.

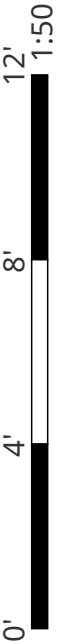

Furnace Room

Width: 3' 1"
Length: 5' 4 3/4"
Area: 16.68 sq ft
Perimeter: 17'
Ceiling Height: 8' 10 1/2"

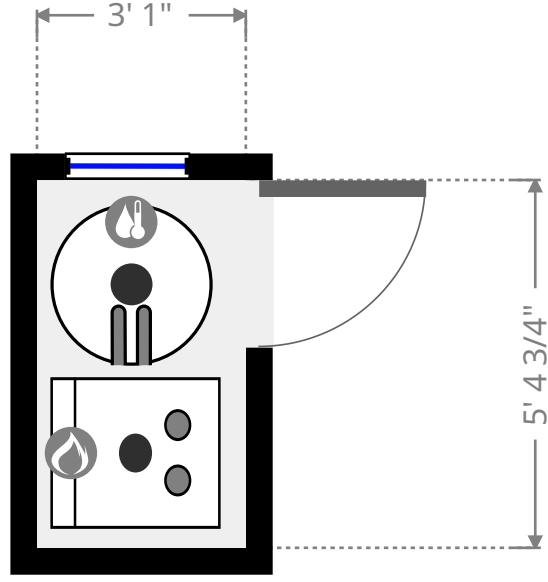
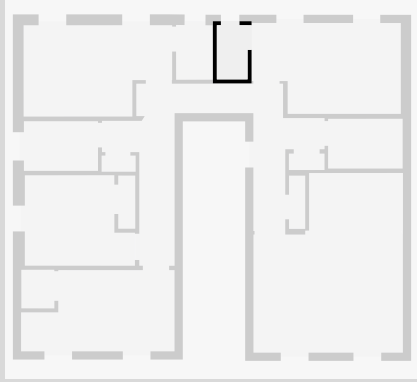

THIS FLOORPLAN IS PROVIDED WITHOUT WARRANTY OF ANY KIND. NAZCA PROPERTIES
DISCLAIMS ANY WARRANTY INCLUDING, WITHOUT LIMITATION, SATISFACTORY QUALITY OR
ACCURACY OF DIMENSIONS.

Bedroom

Width: 9' 1 3/4"
 Length: 14' 10 1/2"
 Area: 121.32 sq ft
 Perimeter: 48'
 Ceiling Height: 8' 10 1/2"

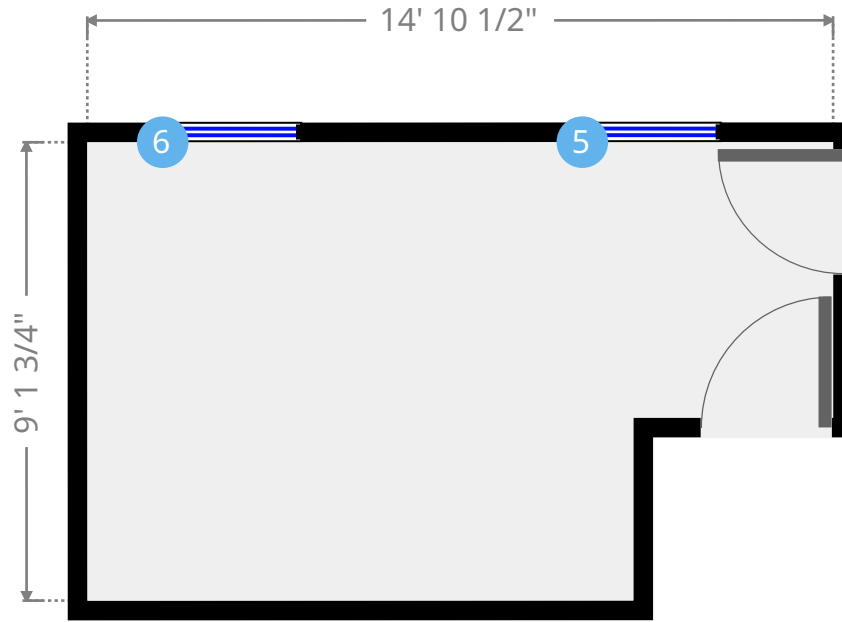
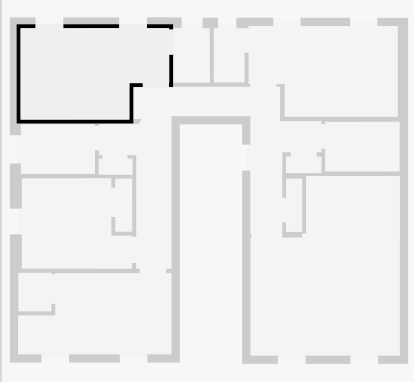

THIS FLOORPLAN IS PROVIDED WITHOUT WARRANTY OF ANY KIND. NAZCA PROPERTIES
 DISCLAIMS ANY WARRANTY INCLUDING, WITHOUT LIMITATION, SATISFACTORY QUALITY OR
 ACCURACY OF DIMENSIONS.

5



Hung Window

- Height: 5' 4"

6



Hung Window

- Height: 5' 4"



Closet

Width: 3' 8 1/4"
Length: 5' 6"
Area: 20.09 sq ft
Perimeter: 18' 3 1/4"
Ceiling Height: 8' 10 1/2"

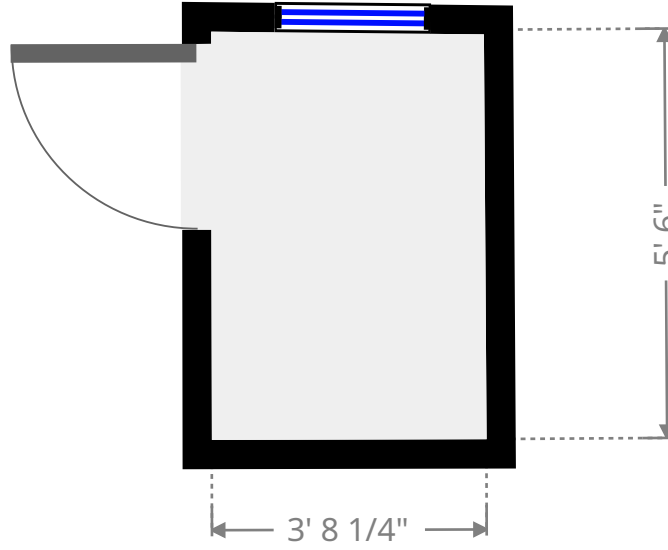
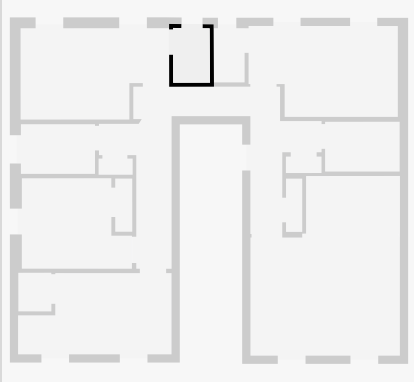

Bathroom

Width: 4' 11 1/4"
Length: 7' 5 1/4"
Area: 36.83 sq ft
Perimeter: 24' 9 1/4"
Ceiling Height: 8' 10 1/2"

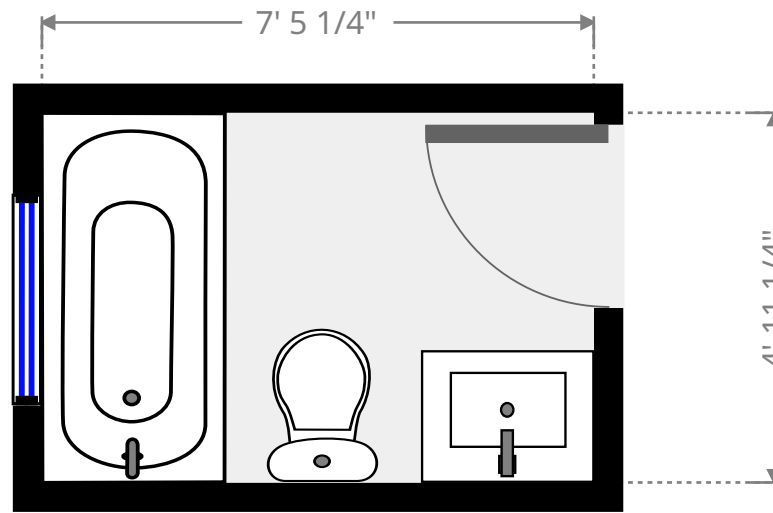
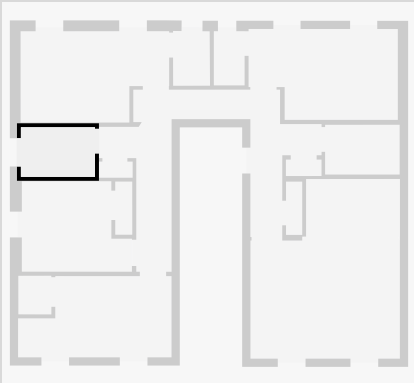

THIS FLOORPLAN IS PROVIDED WITHOUT WARRANTY OF ANY KIND. NAZCA PROPERTIES
DISCLAIMS ANY WARRANTY INCLUDING, WITHOUT LIMITATION, SATISFACTORY QUALITY OR
ACCURACY OF DIMENSIONS.

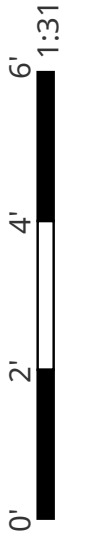

Closet

Width: 1' 7 3/4"
Length: 3' 5"
Area: 5.50 sq ft
Perimeter: 10' 1/2"
Ceiling Height: 8' 10 1/2"

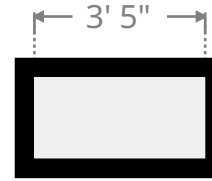
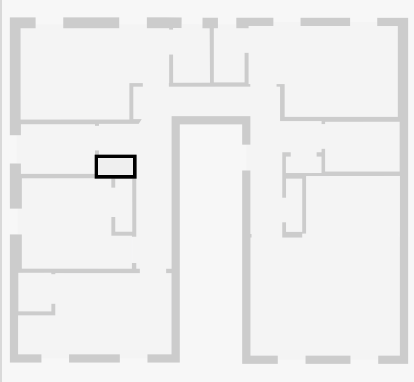

Study

Width: 9' 1/2"
Length: 11' 1/4"
Area: 87.87 sq ft
Perimeter: 40' 1 1/2"
Ceiling Height: 8' 10 1/2"

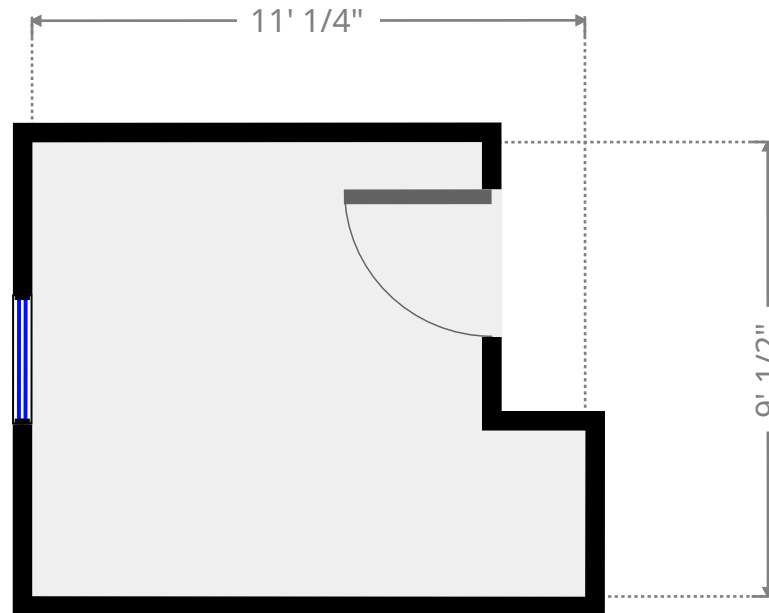
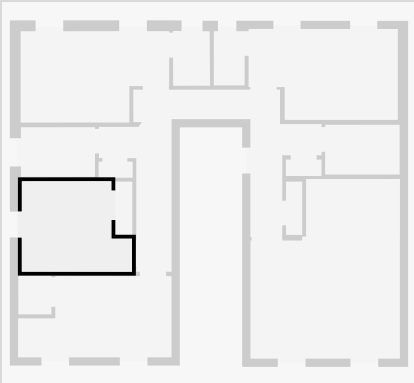

THIS FLOORPLAN IS PROVIDED WITHOUT WARRANTY OF ANY KIND. NAZCA PROPERTIES
DISCLAIMS ANY WARRANTY INCLUDING, WITHOUT LIMITATION, SATISFACTORY QUALITY OR
ACCURACY OF DIMENSIONS.



Closet

Width: 1' 8 1/2"
Length: 5' 3 3/4"
Area: 9.06 sq ft
Perimeter: 14' 1/2"
Ceiling Height: 8' 10 1/2"

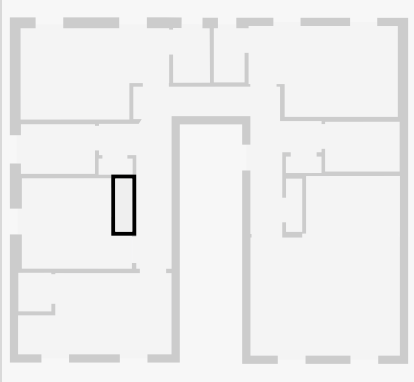

Office

Width: 8' 1 1/4"
Length: 15' 4 1/4"
Area: 109.06 sq ft
Perimeter: 46' 11 1/2"
Ceiling Height: 8' 10 1/2"

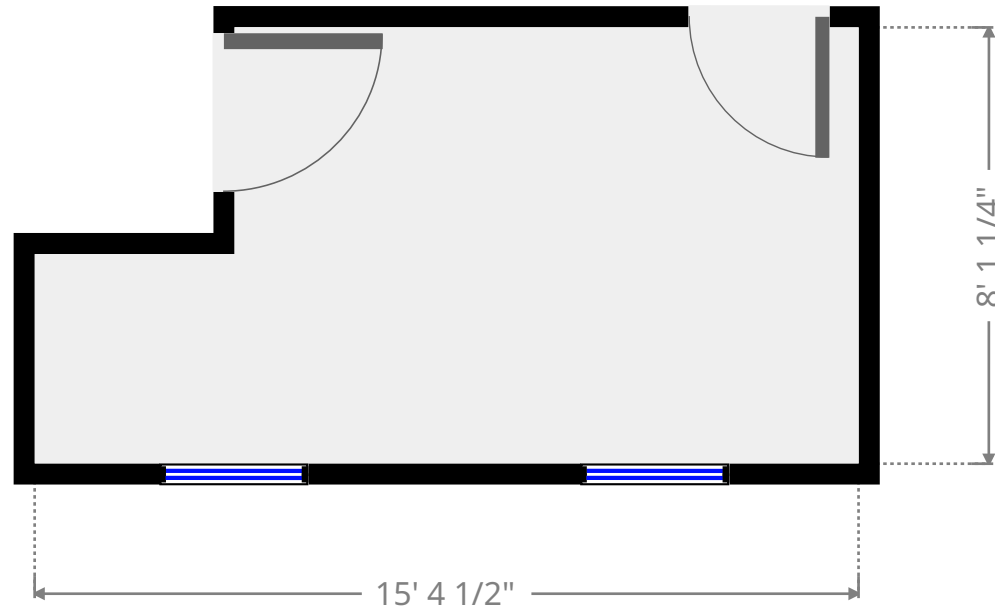
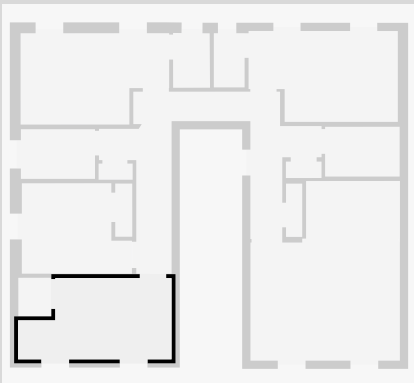

THIS FLOORPLAN IS PROVIDED WITHOUT WARRANTY OF ANY KIND. NAZCA PROPERTIES
DISCLAIMS ANY WARRANTY INCLUDING, WITHOUT LIMITATION, SATISFACTORY QUALITY OR
ACCURACY OF DIMENSIONS.



Closet

Width: 3' 3 3/4"
Length: 3' 10 1/2"
Area: 12.76 sq ft
Perimeter: 14' 4"
Ceiling Height: 8' 10 1/2"

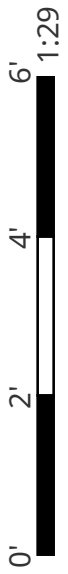
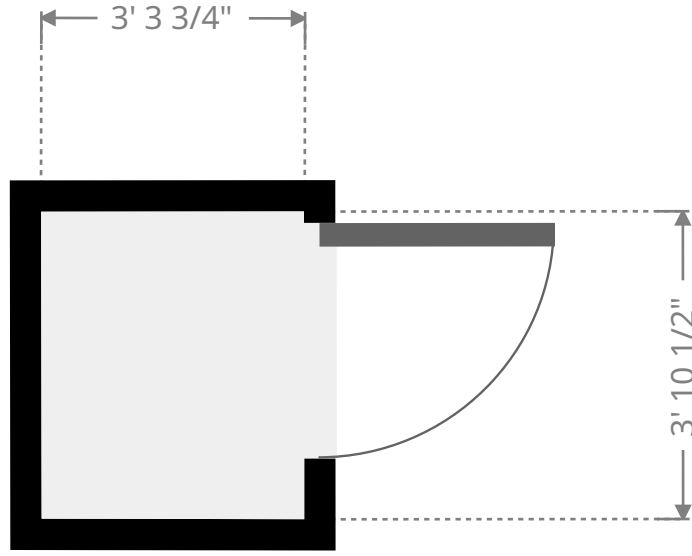
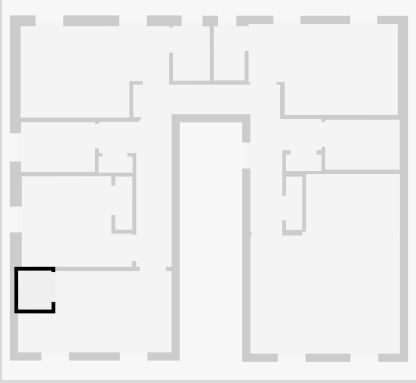

THIS FLOORPLAN IS PROVIDED WITHOUT WARRANTY OF ANY KIND. NAZCA PROPERTIES
DISCLAIMS ANY WARRANTY INCLUDING, WITHOUT LIMITATION, SATISFACTORY QUALITY OR
ACCURACY OF DIMENSIONS.