

**221 Renner St.
Apt. 4**

4th Floor



Nazca Properties
manager@nazcaproperties.com
513-535-2154

Statistics

Area: 1321 sq ft
1 Floor
2 Bedrooms
2 Bathrooms

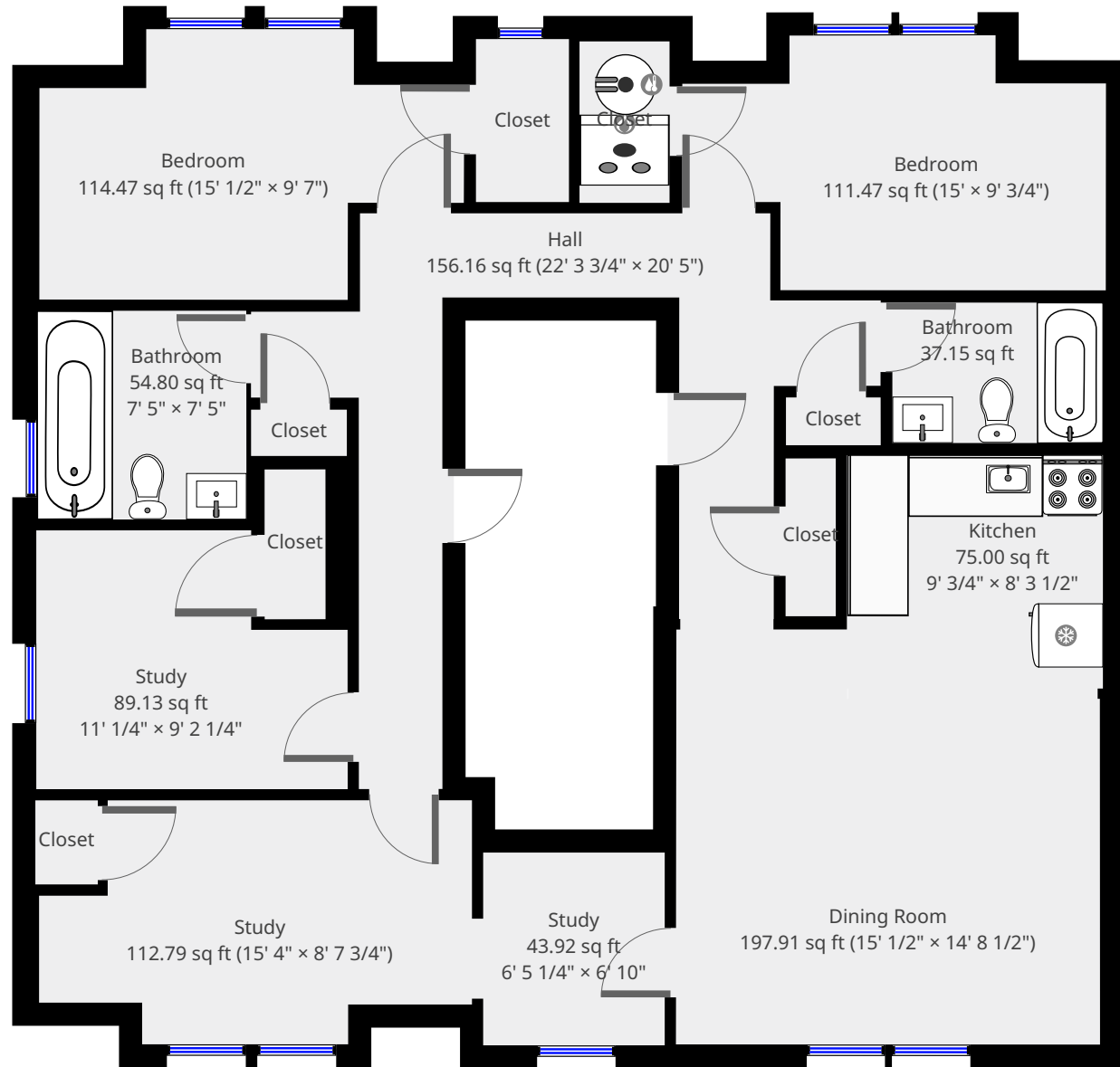

THIS FLOORPLAN IS PROVIDED WITHOUT WARRANTY OF ANY KIND. NAZCA PROPERTIES
DISCLAIMS ANY WARRANTY INCLUDING, WITHOUT LIMITATION, SATISFACTORY QUALITY OR
ACCURACY OF DIMENSIONS.



Closet

Width: 3' 3 1/2"
Length: 5' 9 1/4"
Area: 19.02 sq ft
Perimeter: 18' 1 3/4"

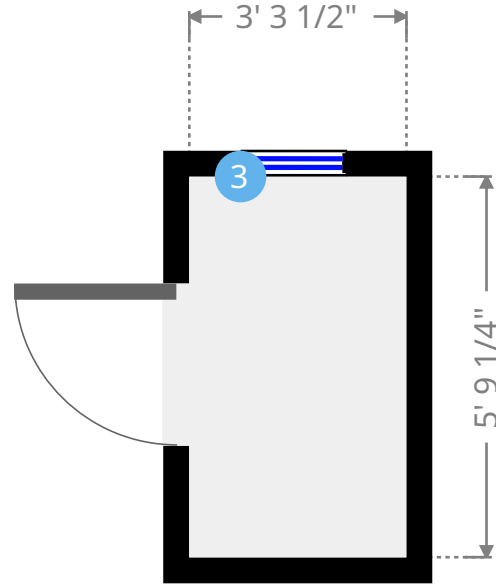
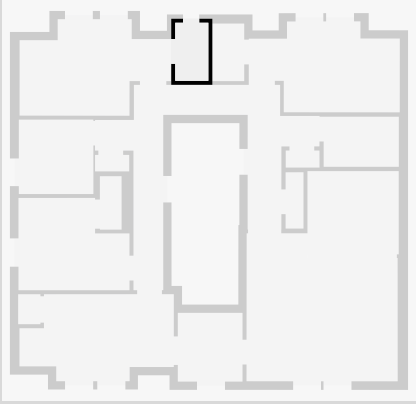

3



Hung Window

- Height: 2' 9 1/2"

THIS FLOORPLAN IS PROVIDED WITHOUT WARRANTY OF ANY KIND. NAZCA PROPERTIES
DISCLAIMS ANY WARRANTY INCLUDING, WITHOUT LIMITATION, SATISFACTORY QUALITY OR
ACCURACY OF DIMENSIONS.

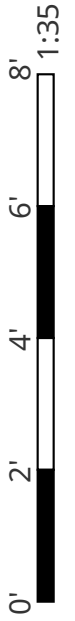

Study

Width: 6' 5 1/4"
Length: 6' 10"
Area: 43.92 sq ft
Perimeter: 26' 6 1/4"
Ceiling Height: 8' 3 1/2"

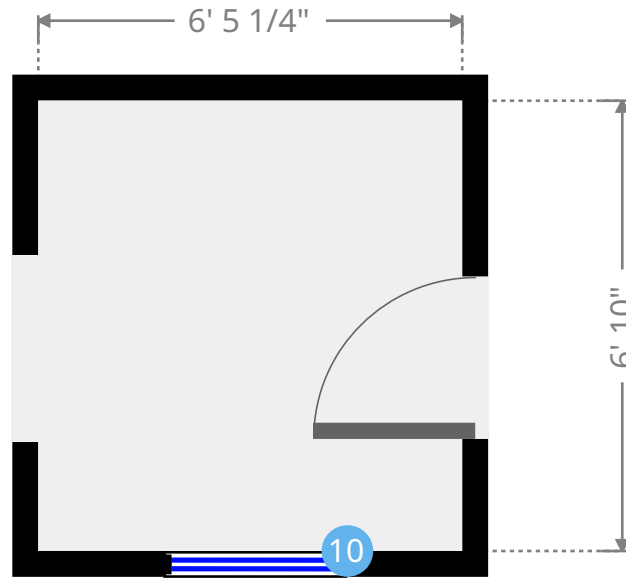
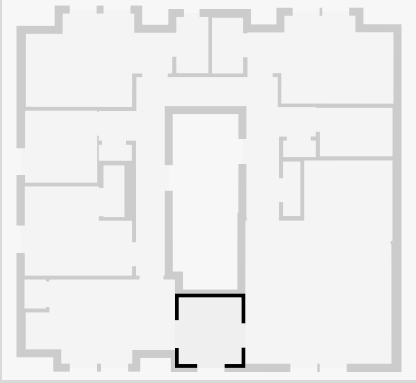

10



Hung Window

- Height: 4' 7 1/2"

THIS FLOORPLAN IS PROVIDED WITHOUT WARRANTY OF ANY KIND. NAZCA PROPERTIES
DISCLAIMS ANY WARRANTY INCLUDING, WITHOUT LIMITATION, SATISFACTORY QUALITY OR
ACCURACY OF DIMENSIONS.

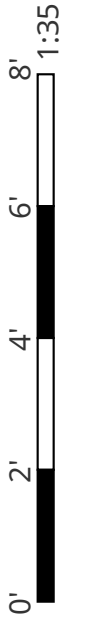

Closet

Width: 2' 2 1/2"
Length: 2' 11 3/4"
Area: 6.59 sq ft
Perimeter: 10' 4 1/2"

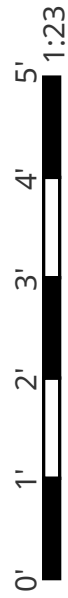
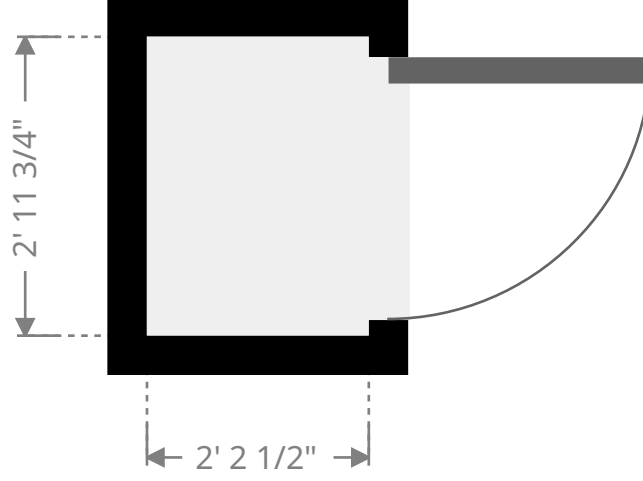
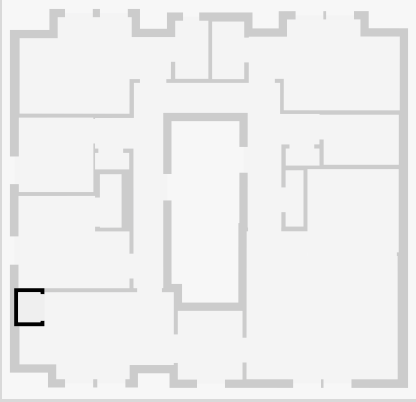

THIS FLOORPLAN IS PROVIDED WITHOUT WARRANTY OF ANY KIND. NAZCA PROPERTIES
DISCLAIMS ANY WARRANTY INCLUDING, WITHOUT LIMITATION, SATISFACTORY QUALITY OR
ACCURACY OF DIMENSIONS.

Study

Width: 8' 7 3/4"
Length: 15' 4"
Area: 112.79 sq ft
Perimeter: 47' 11 1/2"
Ceiling Height: 8' 4 1/4"

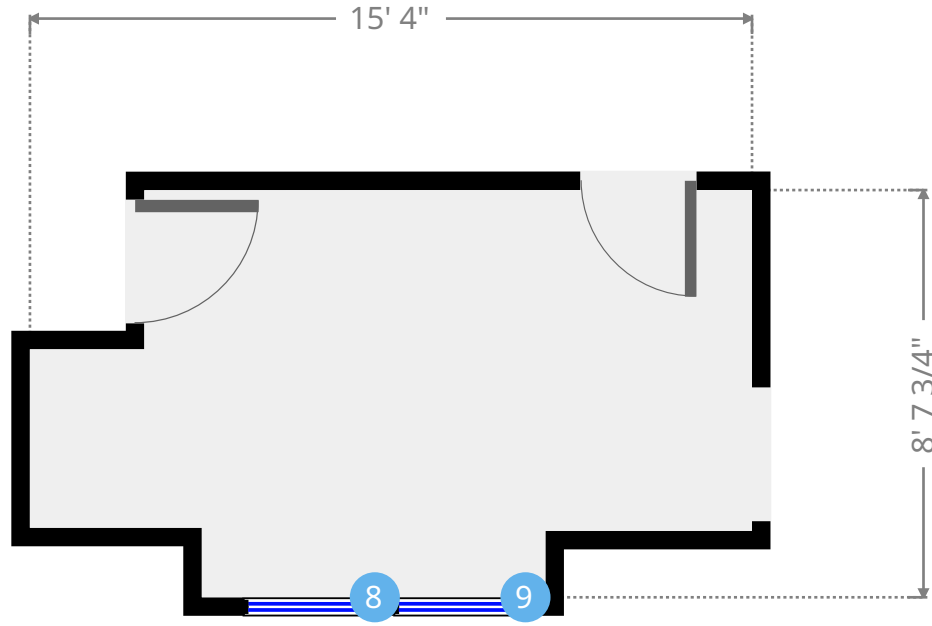
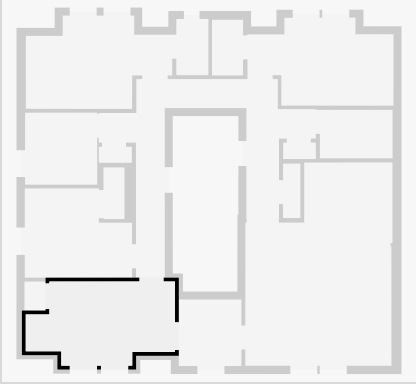

8



Hung Window

- Height: 4' 8 3/4"

9



Hung Window

- Height: 4' 8 1/2"

THIS FLOORPLAN IS PROVIDED WITHOUT WARRANTY OF ANY KIND. NAZCA PROPERTIES
DISCLAIMS ANY WARRANTY INCLUDING, WITHOUT LIMITATION, SATISFACTORY QUALITY OR
ACCURACY OF DIMENSIONS.

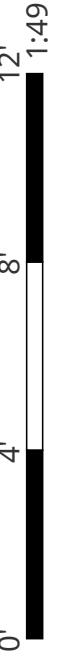

Study

Width: 9' 2 1/4"
Length: 11' 1/4"
Area: 89.13 sq ft
Perimeter: 40' 5"
Ceiling Height: 8' 4"

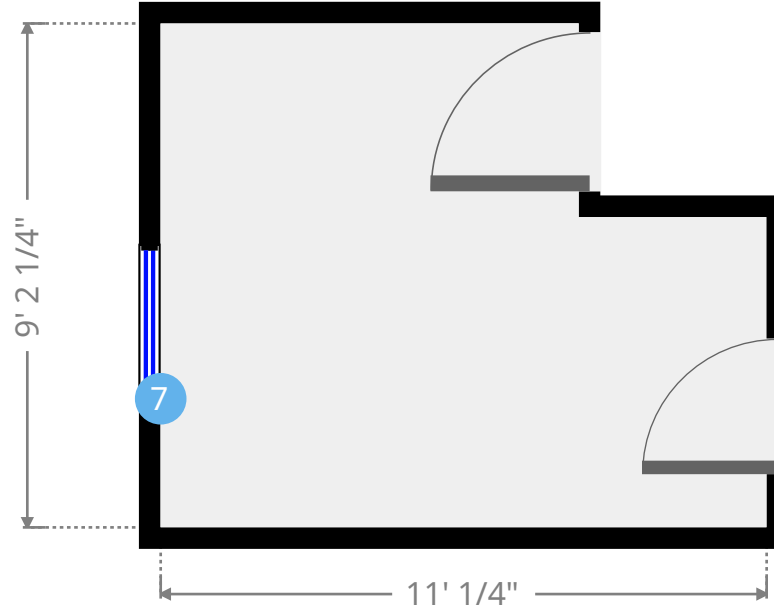
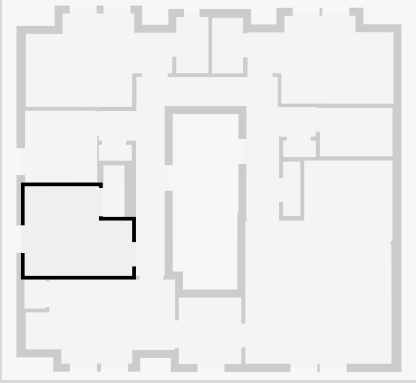

7



Hung Window

- Height: 5' 3/4"

THIS FLOORPLAN IS PROVIDED WITHOUT WARRANTY OF ANY KIND. NAZCA PROPERTIES
DISCLAIMS ANY WARRANTY INCLUDING, WITHOUT LIMITATION, SATISFACTORY QUALITY OR
ACCURACY OF DIMENSIONS.



Closet

Width: 2' 2"
Length: 5' 3 3/4"
Area: 11.45 sq ft
Perimeter: 14' 11 1/4"

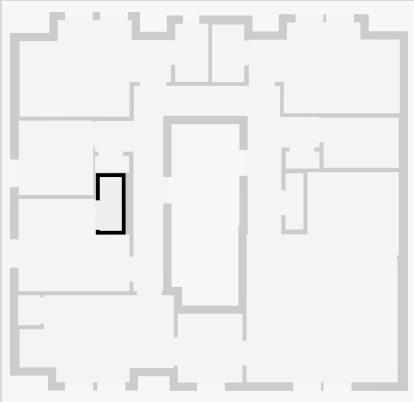

Closet

Width: 1' 7 3/4"
Length: 3' 4 3/4"
Area: 5.56 sq ft
Perimeter: 10' 3/4"

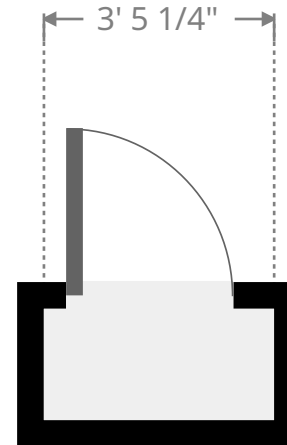
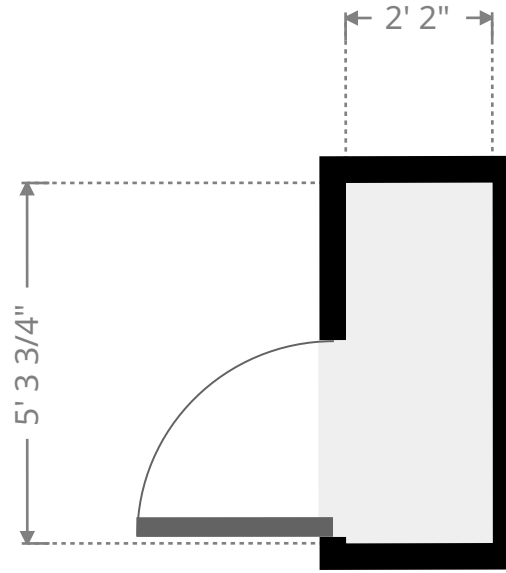
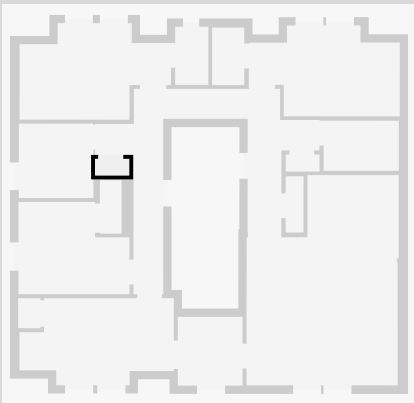

THIS FLOORPLAN IS PROVIDED WITHOUT WARRANTY OF ANY KIND. NAZCA PROPERTIES
DISCLAIMS ANY WARRANTY INCLUDING, WITHOUT LIMITATION, SATISFACTORY QUALITY OR
ACCURACY OF DIMENSIONS.



Bathroom

Width: 7' 5"
Length: 7' 5"
Area: 54.80 sq ft
Perimeter: 29' 7 1/4"
Ceiling Height: 8' 1/2"

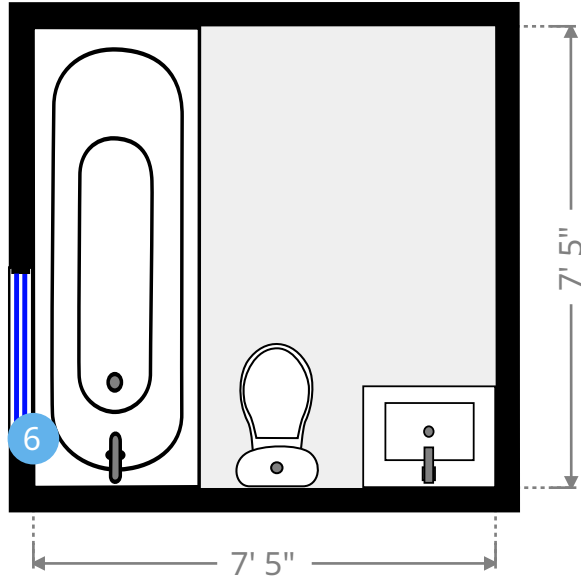
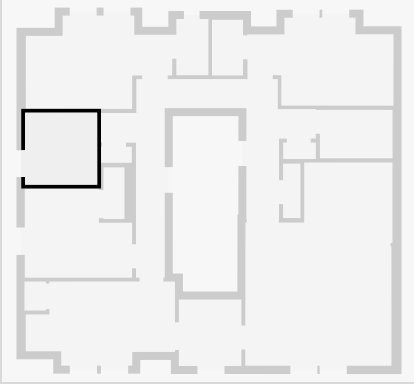

6



Hung Window

- Height: 3' 10 1/4"

THIS FLOORPLAN IS PROVIDED WITHOUT WARRANTY OF ANY KIND. NAZCA PROPERTIES
DISCLAIMS ANY WARRANTY INCLUDING, WITHOUT LIMITATION, SATISFACTORY QUALITY OR
ACCURACY OF DIMENSIONS.



Bedroom

Width: 9' 7"
Length: 15' 1/2"
Area: 114.47 sq ft
Perimeter: 49' 3"
Ceiling Height: 7' 9"

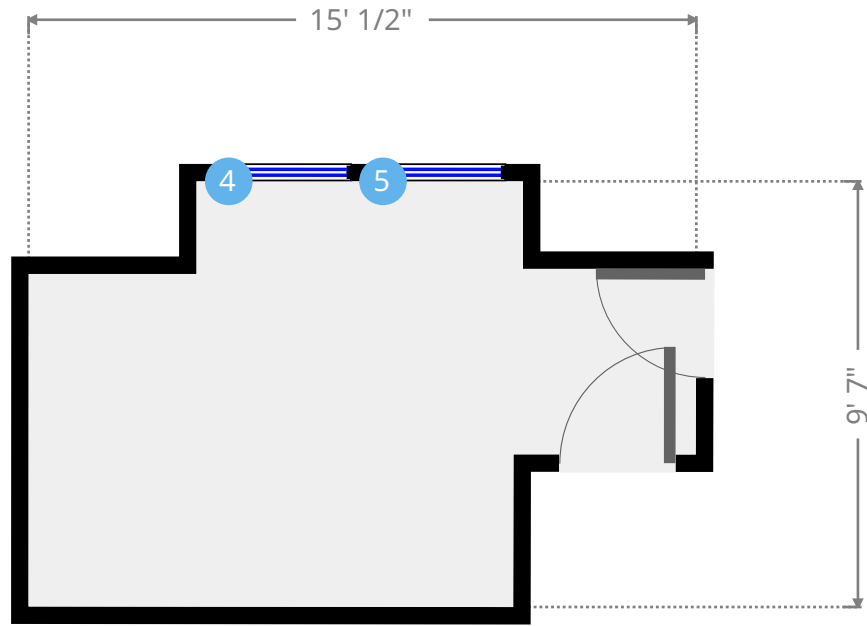
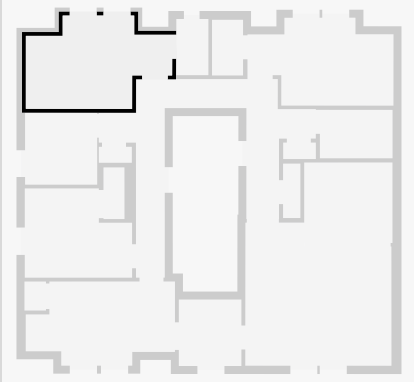

4



Hung Window

- Height: 4' 11 3/4"

5



Hung Window

- Height: 4' 11 3/4"

THIS FLOORPLAN IS PROVIDED WITHOUT WARRANTY OF ANY KIND. NAZCA PROPERTIES
DISCLAIMS ANY WARRANTY INCLUDING, WITHOUT LIMITATION, SATISFACTORY QUALITY OR
ACCURACY OF DIMENSIONS.

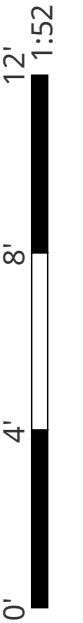

Hall

Width: 20' 5"
Length: 22' 3 3/4"
Area: 156.16 sq ft
Perimeter: 108' 2 1/2"
Ceiling Height: 7'

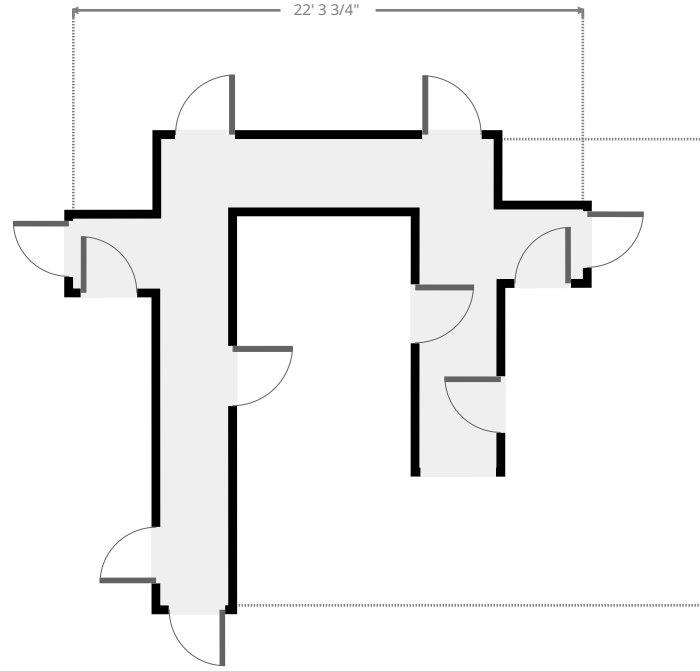
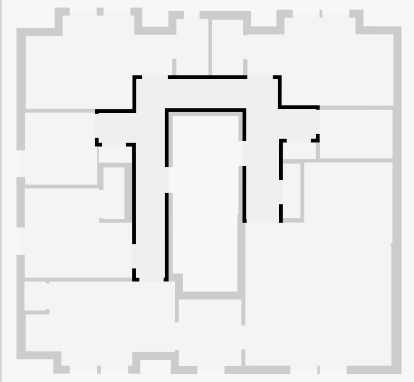

Closet

Width: 3' 2 1/4"
Length: 5' 8 3/4"
Area: 18.25 sq ft
Perimeter: 17' 9 3/4"

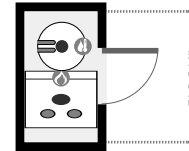
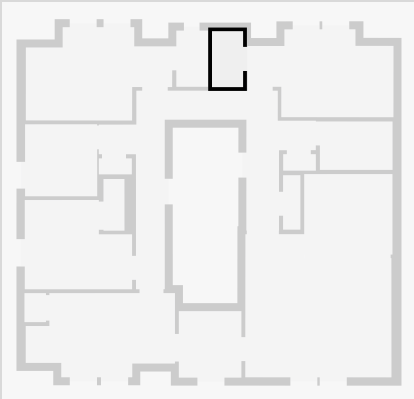

THIS FLOORPLAN IS PROVIDED WITHOUT WARRANTY OF ANY KIND. NAZCA PROPERTIES
DISCLAIMS ANY WARRANTY INCLUDING, WITHOUT LIMITATION, SATISFACTORY QUALITY OR
ACCURACY OF DIMENSIONS.

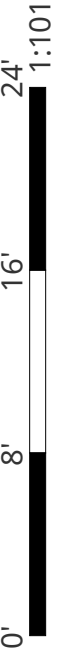

Bedroom

Width: 9' 3/4"
Length: 15'
Area: 111.47 sq ft
Perimeter: 48' 3/4"

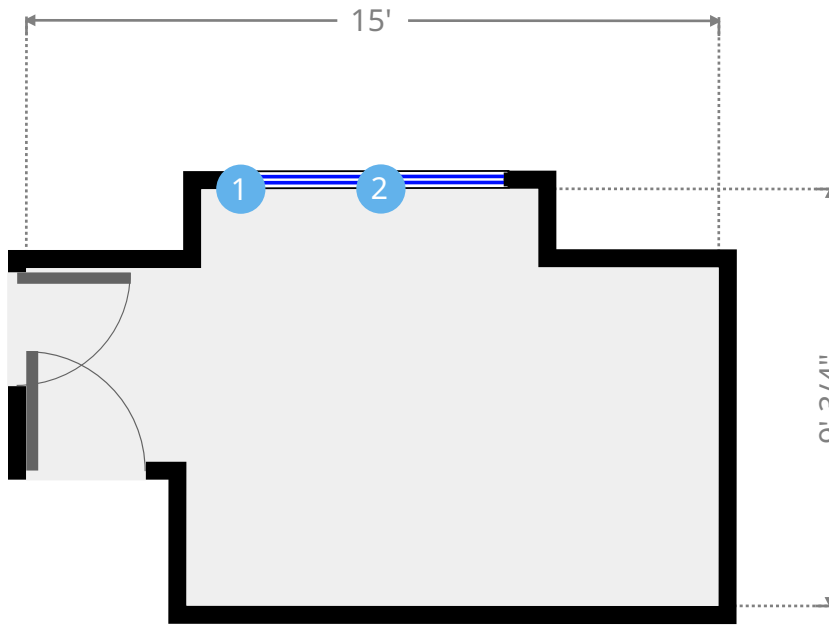
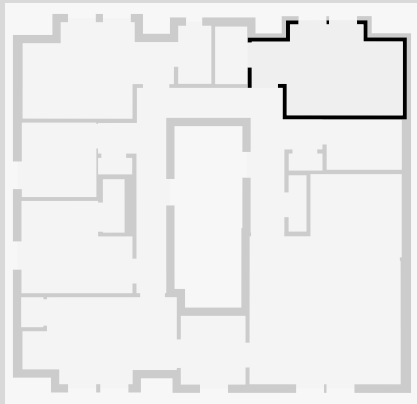

1



Hung Window

- Height: 4' 9 1/4"

2



Hung Window

- Height: 4' 9 3/4"

THIS FLOORPLAN IS PROVIDED WITHOUT WARRANTY OF ANY KIND. NAZCA PROPERTIES
DISCLAIMS ANY WARRANTY INCLUDING, WITHOUT LIMITATION, SATISFACTORY QUALITY OR
ACCURACY OF DIMENSIONS.

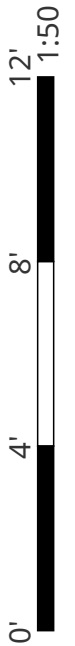

Bathroom

Width: 4' 11 3/4"
Length: 7' 5 1/2"
Area: 37.15 sq ft
Perimeter: 24' 10 1/2"

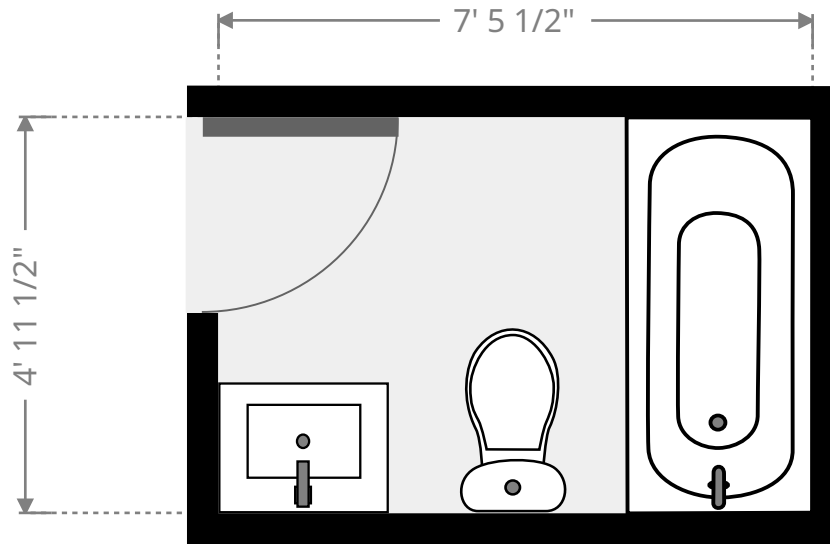
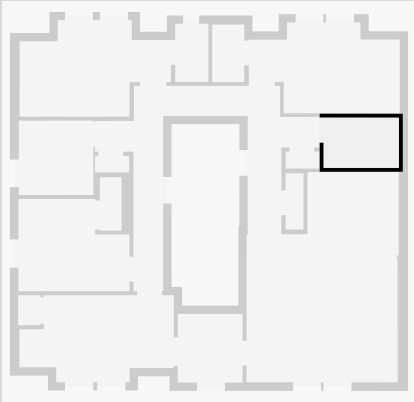

Closet

Width: 1' 8 1/4"
Length: 3' 4 1/4"
Area: 5.68 sq ft
Perimeter: 10' 1 1/4"

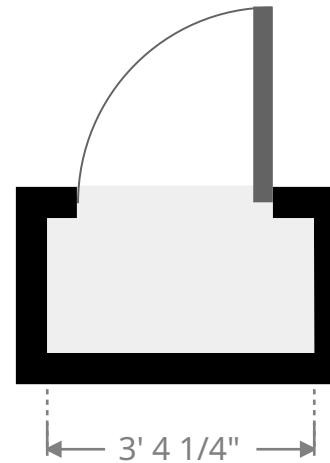
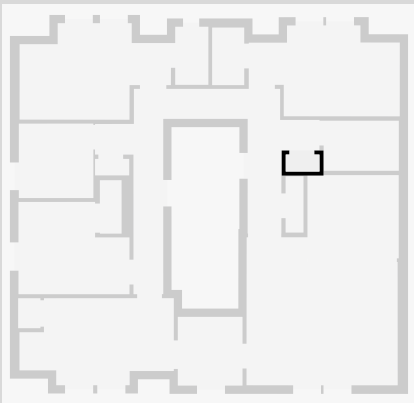

THIS FLOORPLAN IS PROVIDED WITHOUT WARRANTY OF ANY KIND. NAZCA PROPERTIES
DISCLAIMS ANY WARRANTY INCLUDING, WITHOUT LIMITATION, SATISFACTORY QUALITY OR
ACCURACY OF DIMENSIONS.

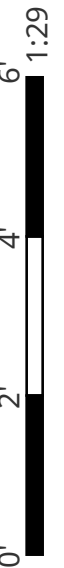

Closet

Width: 1' 9 1/2"
Length: 5' 7 1/4"
Area: 9.95 sq ft
Perimeter: 14' 9"

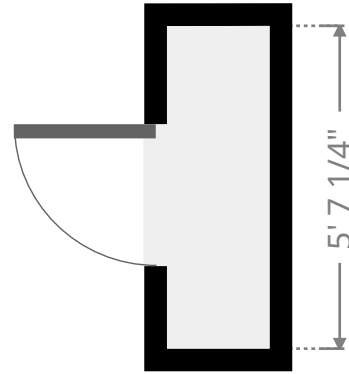
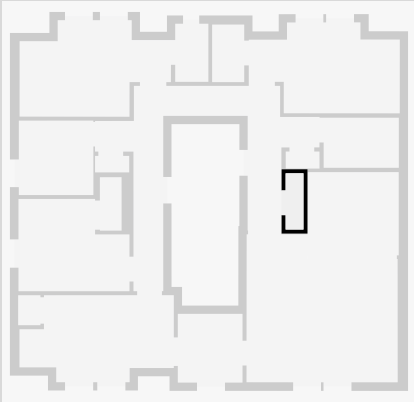

Kitchen

Width: 8' 3 1/2"
Length: 9' 3/4"
Area: 75.00 sq ft
Perimeter: 34' 8 1/4"
Ceiling Height: 8' 3 1/4"

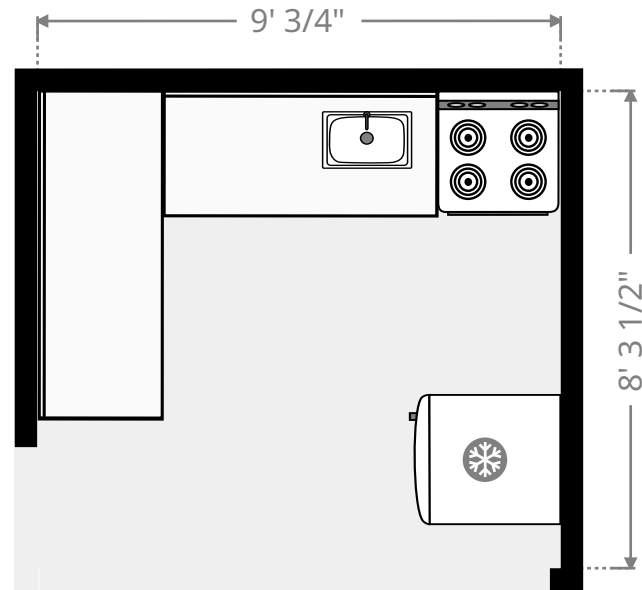
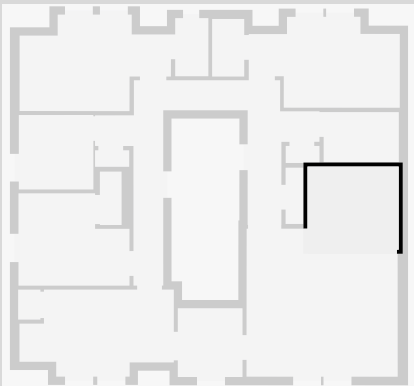

THIS FLOORPLAN IS PROVIDED WITHOUT WARRANTY OF ANY KIND. NAZCA PROPERTIES
DISCLAIMS ANY WARRANTY INCLUDING, WITHOUT LIMITATION, SATISFACTORY QUALITY OR
ACCURACY OF DIMENSIONS.



Dining Room

Width: 14' 8 1/2"
Length: 15' 1/2"
Area: 197.91 sq ft
Perimeter: 59' 5 1/4"
Ceiling Height: 8' 3 1/4"

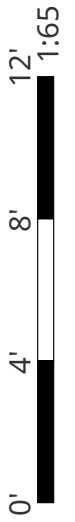
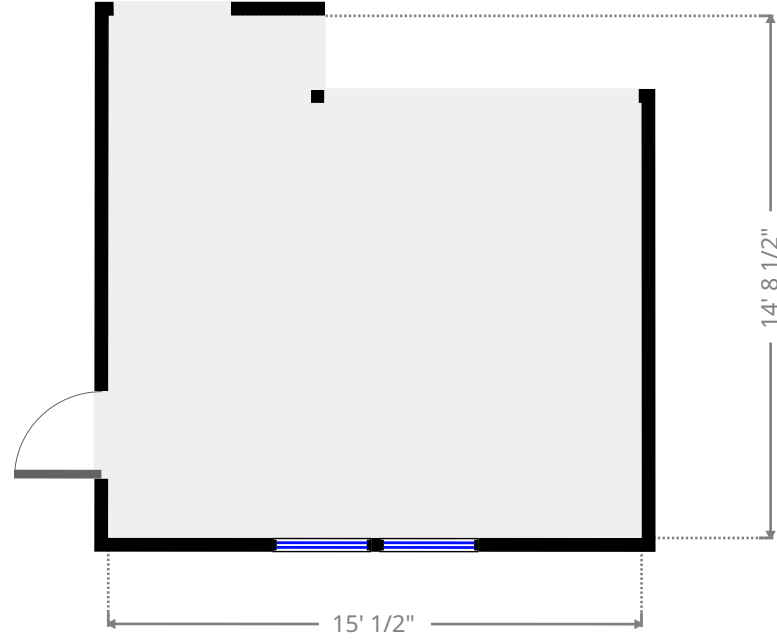
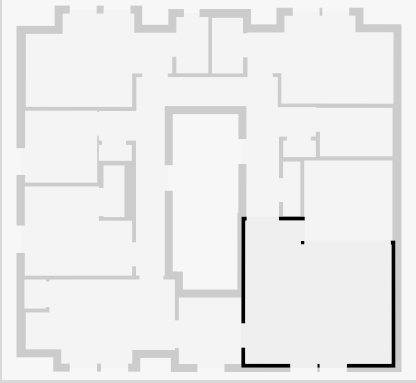

THIS FLOORPLAN IS PROVIDED WITHOUT WARRANTY OF ANY KIND. NAZCA PROPERTIES
DISCLAIMS ANY WARRANTY INCLUDING, WITHOUT LIMITATION, SATISFACTORY QUALITY OR
ACCURACY OF DIMENSIONS.