

2385 Vine St. Apt. 1



Nazca Properties
manager@nazcaproperties.com
513-535-2154

Statistics

Area: 686 sq ft
1 Floor
1 Bedroom
1 Bathroom

1st Floor

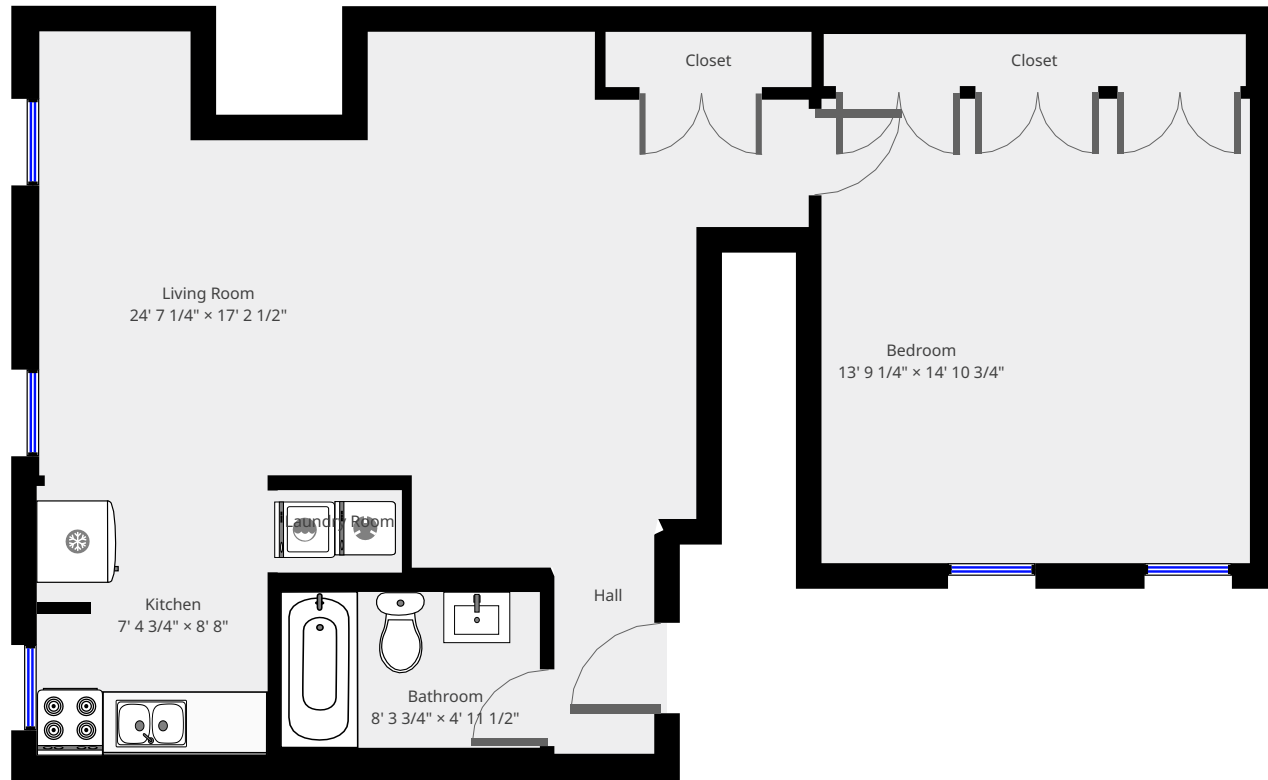

THIS FLOORPLAN IS PROVIDED WITHOUT WARRANTY OF ANY KIND. NAZCA PROPERTIES
DISCLAIMS ANY WARRANTY INCLUDING, WITHOUT LIMITATION, SATISFACTORY QUALITY OR
ACCURACY OF DIMENSIONS.



Hall

Width: 3' 2 1/2"
Length: 7' 1/2"
Area: 20.40 sq ft
Perimeter: 19' 5"

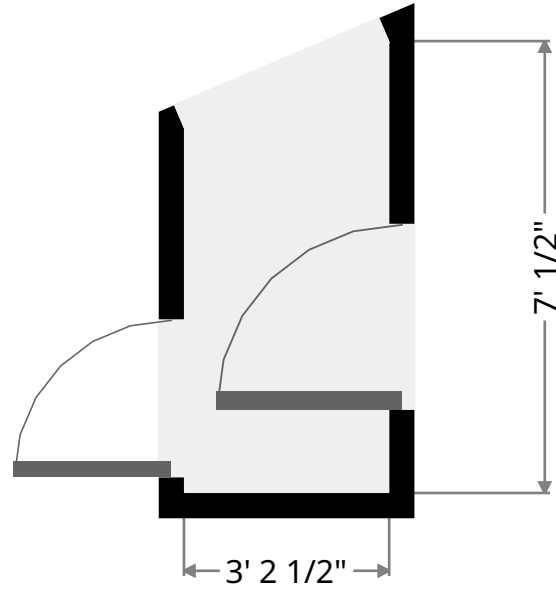
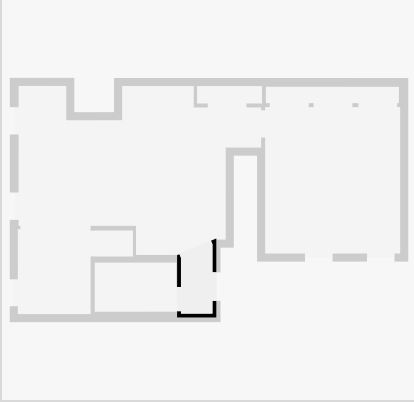

Bathroom

Width: 4' 11 1/2"
Length: 8' 3 3/4"
Area: 41.51 sq ft
Perimeter: 26' 7 1/4"

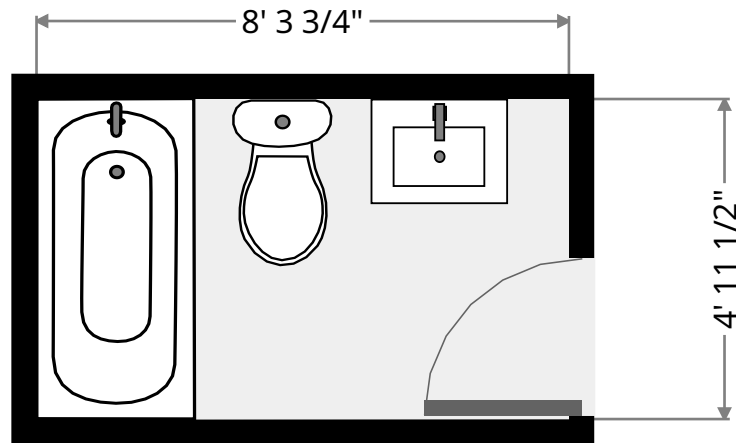
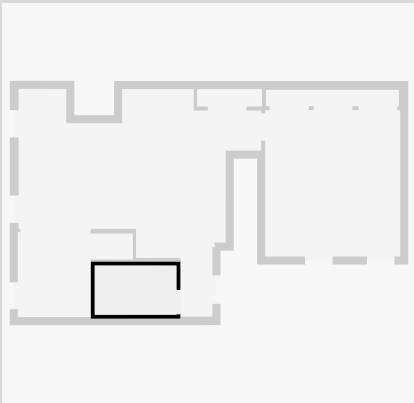

THIS FLOORPLAN IS PROVIDED WITHOUT WARRANTY OF ANY KIND. NAZCA PROPERTIES
DISCLAIMS ANY WARRANTY INCLUDING, WITHOUT LIMITATION, SATISFACTORY QUALITY OR
ACCURACY OF DIMENSIONS.



Living Room

Width: 17' 2 1/2"
Length: 24' 7 1/4"
Area: 310.19 sq ft
Perimeter: 89' 6"

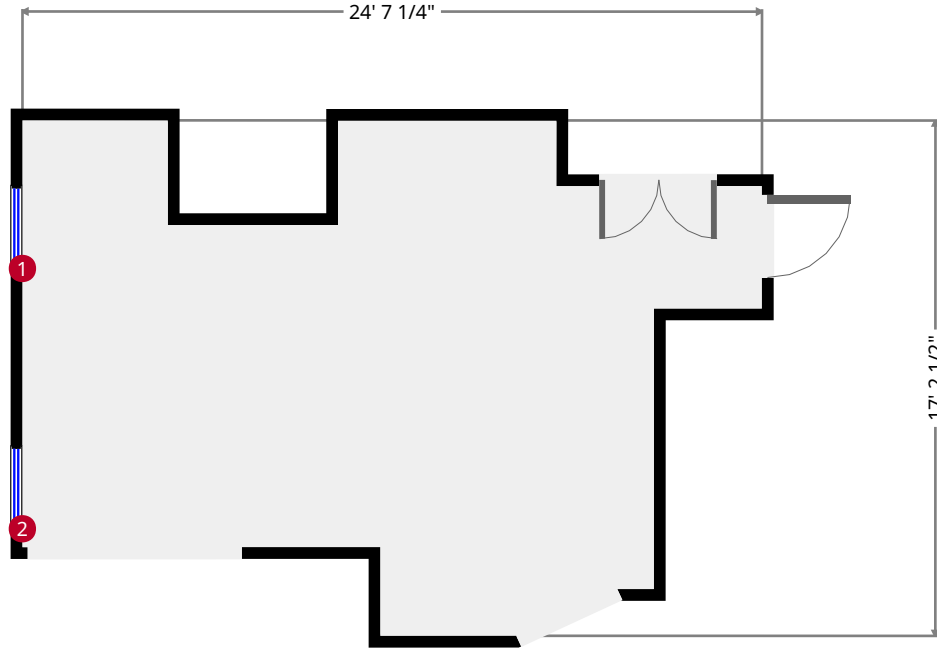
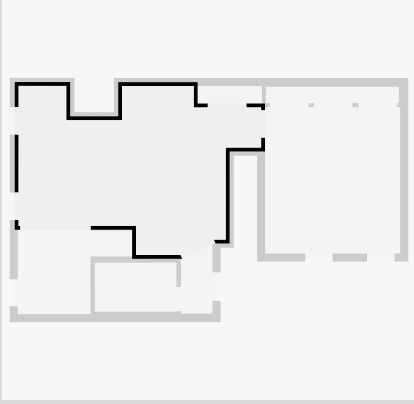

1



Hung Window

- Height: 6' 3 3/4"

2



Hung Window

- Height: 6' 3 3/4"

THIS FLOORPLAN IS PROVIDED WITHOUT WARRANTY OF ANY KIND. NAZCA PROPERTIES
DISCLAIMS ANY WARRANTY INCLUDING, WITHOUT LIMITATION, SATISFACTORY QUALITY OR
ACCURACY OF DIMENSIONS.

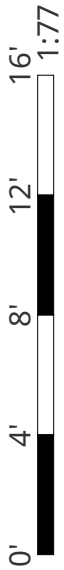

Bedroom

Width: 13' 9 1/4"
Length: 14' 10 3/4"
Area: 204.66 sq ft
Perimeter: 57' 3 1/4"

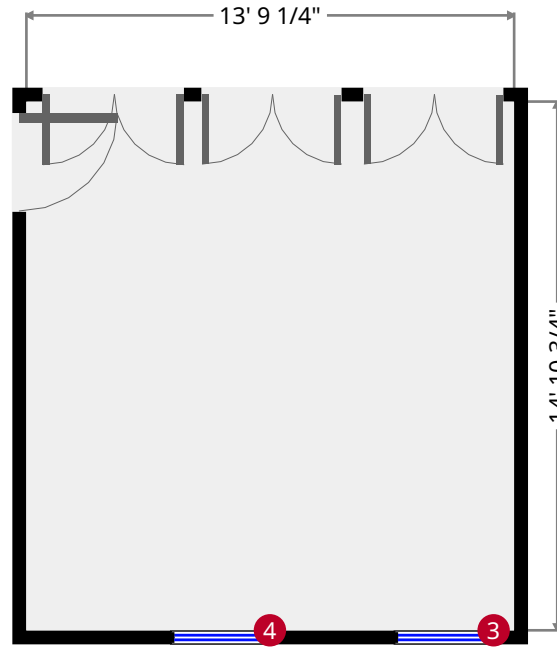
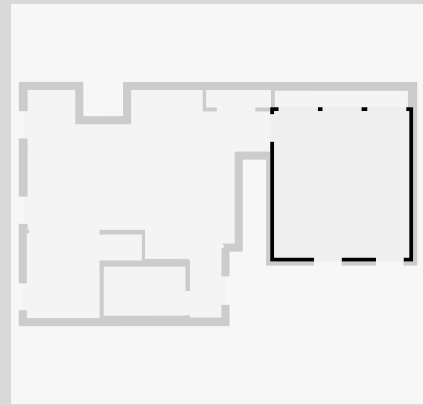

3



Hung Window

- Height: 6' 3"

4



Hung Window

- Height: 6' 3"

THIS FLOORPLAN IS PROVIDED WITHOUT WARRANTY OF ANY KIND. NAZCA PROPERTIES
DISCLAIMS ANY WARRANTY INCLUDING, WITHOUT LIMITATION, SATISFACTORY QUALITY OR
ACCURACY OF DIMENSIONS.

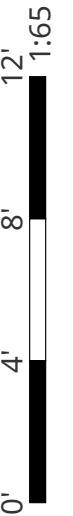

Closet

Width: 1' 7 3/4"
Length: 13' 6 1/2"
Area: 22.56 sq ft
Perimeter: 30' 5"

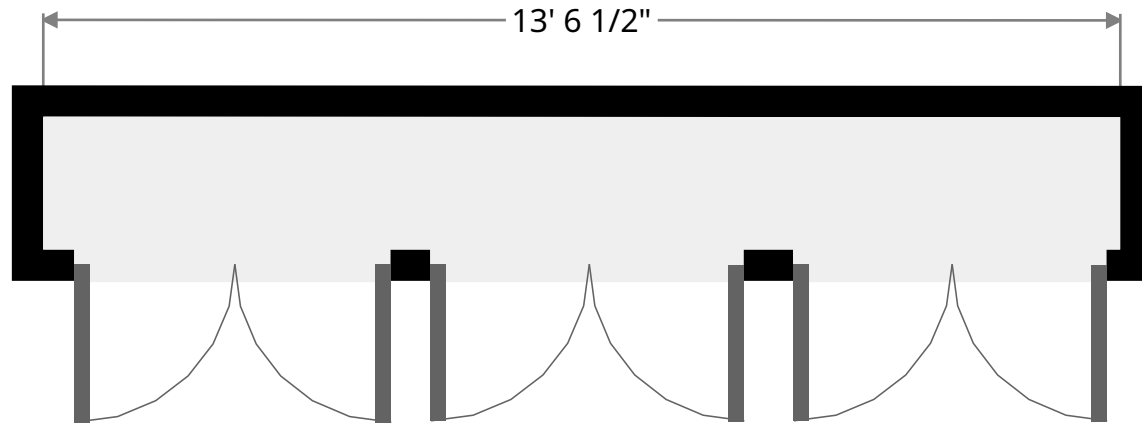
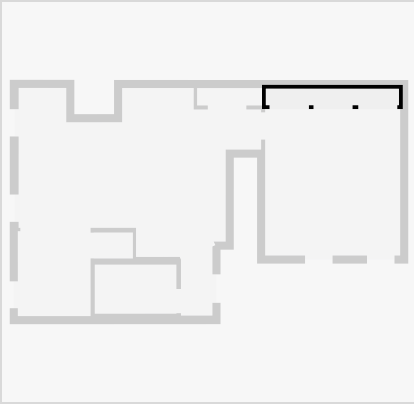

Closet

Width: 1' 9 1/4"
Length: 6' 7 1/4"
Area: 11.71 sq ft
Perimeter: 16' 9"

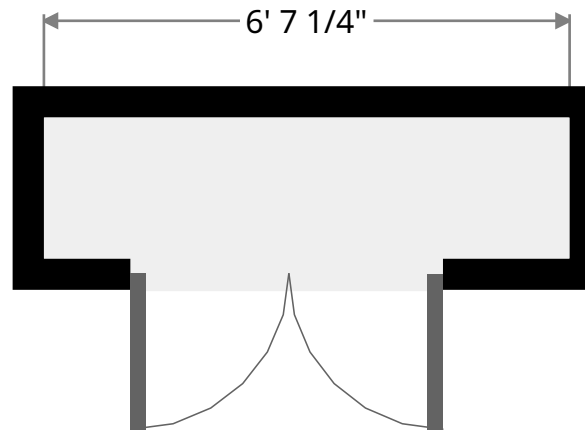
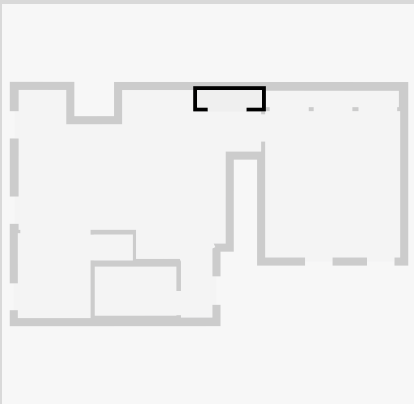

THIS FLOORPLAN IS PROVIDED WITHOUT WARRANTY OF ANY KIND. NAZCA PROPERTIES
DISCLAIMS ANY WARRANTY INCLUDING, WITHOUT LIMITATION, SATISFACTORY QUALITY OR
ACCURACY OF DIMENSIONS.

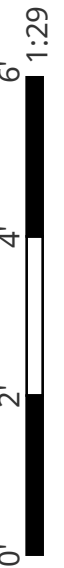

Laundry Room

Width: 2' 7 3/4"
Length: 3' 11 3/4"
Area: 10.53 sq ft
Perimeter: 13' 3"

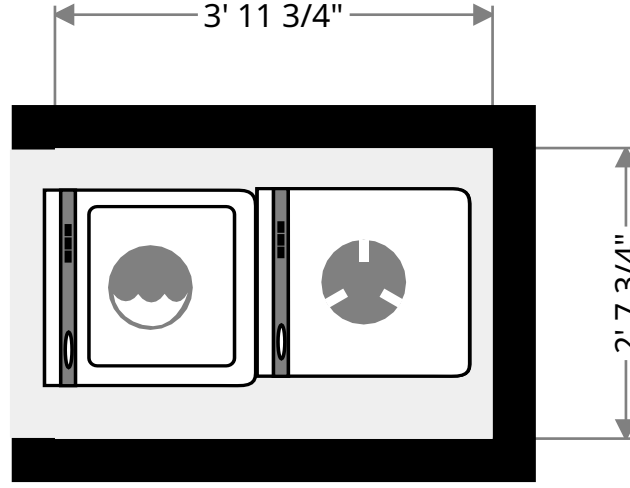
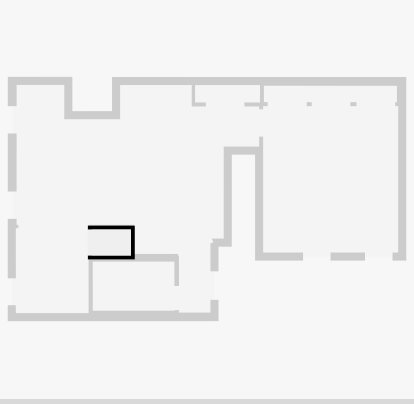

THIS FLOORPLAN IS PROVIDED WITHOUT WARRANTY OF ANY KIND. NAZCA PROPERTIES
DISCLAIMS ANY WARRANTY INCLUDING, WITHOUT LIMITATION, SATISFACTORY QUALITY OR
ACCURACY OF DIMENSIONS.

Kitchen

Width: 7' 4 3/4"
Length: 8' 8"
Area: 63.99 sq ft
Perimeter: 32' 1"

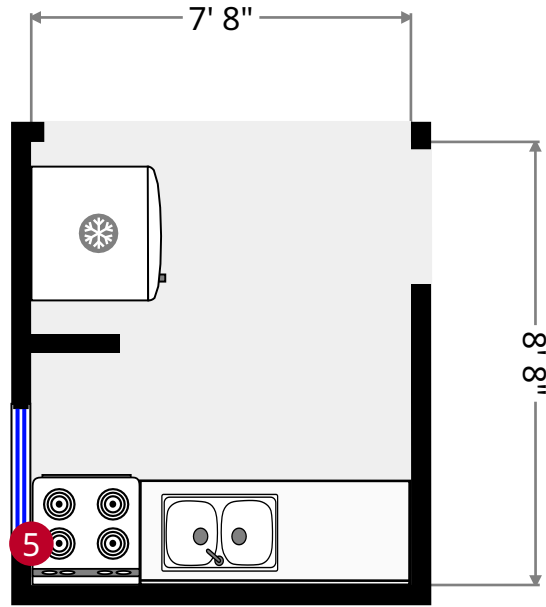
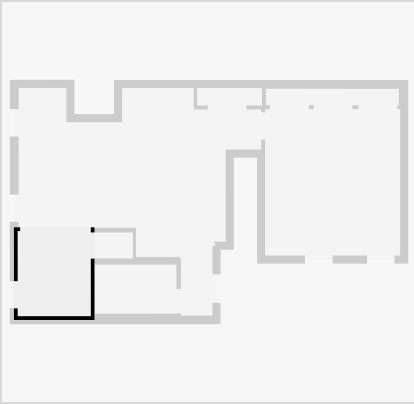

5



Hung Window

- Height: 6' 4 1/2"

THIS FLOORPLAN IS PROVIDED WITHOUT WARRANTY OF ANY KIND. NAZCA PROPERTIES
DISCLAIMS ANY WARRANTY INCLUDING, WITHOUT LIMITATION, SATISFACTORY QUALITY OR
ACCURACY OF DIMENSIONS.

