

**2385 Vine St.  
Apt. 2**



2385 Vine Street, Cincinnati, Ohio, USA 45219



**Nazca Properties**  
manager@nazcaproperties.com  
513-535-2154

**Statistics**

Area: 1546 sq ft  
2 Floors  
3 Bedrooms  
2 Bathrooms

2nd Floor

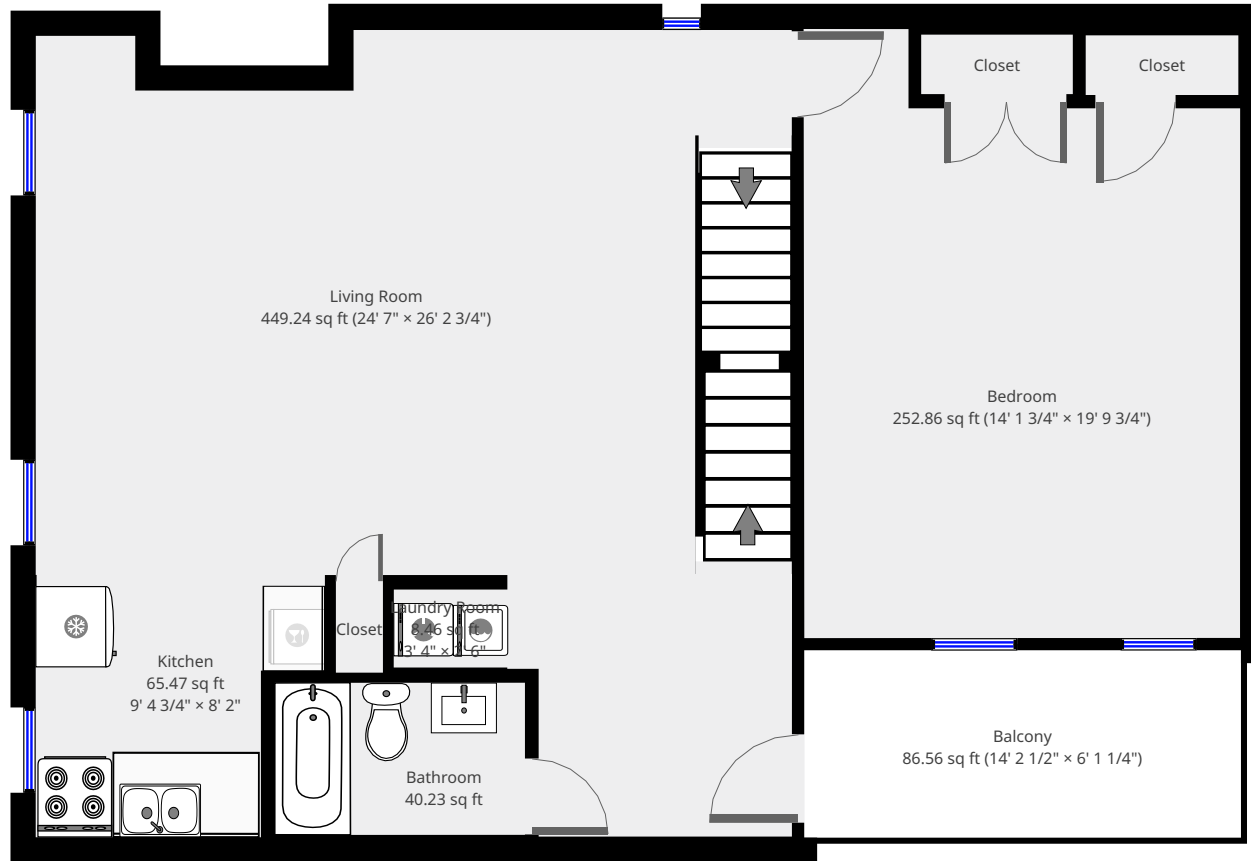

THIS FLOORPLAN IS PROVIDED WITHOUT WARRANTY OF ANY KIND. NAZCA PROPERTIES  
DISCLAIMS ANY WARRANTY INCLUDING, WITHOUT LIMITATION, SATISFACTORY QUALITY OR  
ACCURACY OF DIMENSIONS.



# Living Room

Width: 24' 7"  
 Length: 26' 2 3/4"  
 Area: 449.24 sq ft  
 Perimeter: 111' 5 1/4"  
 Ceiling Height: 9' 11 1/4"

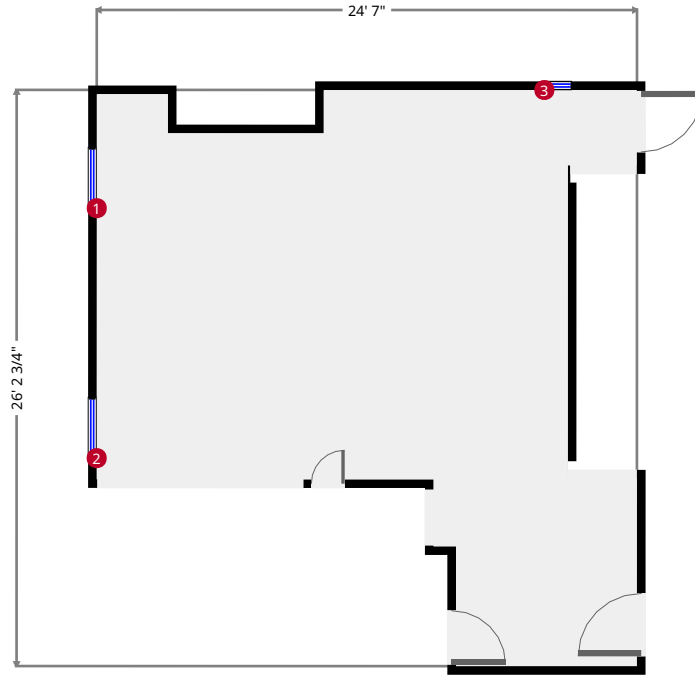
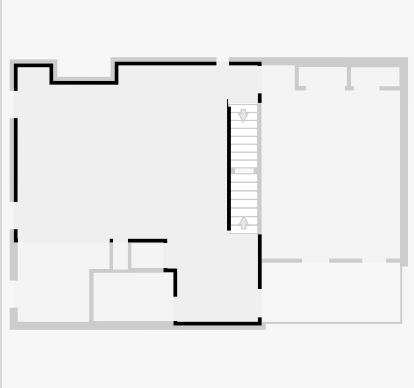

1



Hung Window

- Height: 6' 4 1/2"

2



Hung Window

- Height: 6' 4 1/2"

3



Hung Window

- Height: 4'

THIS FLOORPLAN IS PROVIDED WITHOUT WARRANTY OF ANY KIND. NAZCA PROPERTIES  
 DISCLAIMS ANY WARRANTY INCLUDING, WITHOUT LIMITATION, SATISFACTORY QUALITY OR  
 ACCURACY OF DIMENSIONS.

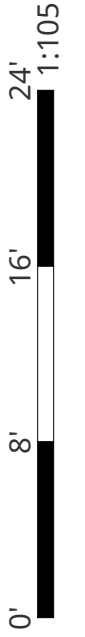

# Kitchen

Width: 8' 2"  
 Length: 9' 4 3/4"  
 Area: 65.47 sq ft  
 Perimeter: 35' 1 1/2"  
 Ceiling Height: 9' 11"

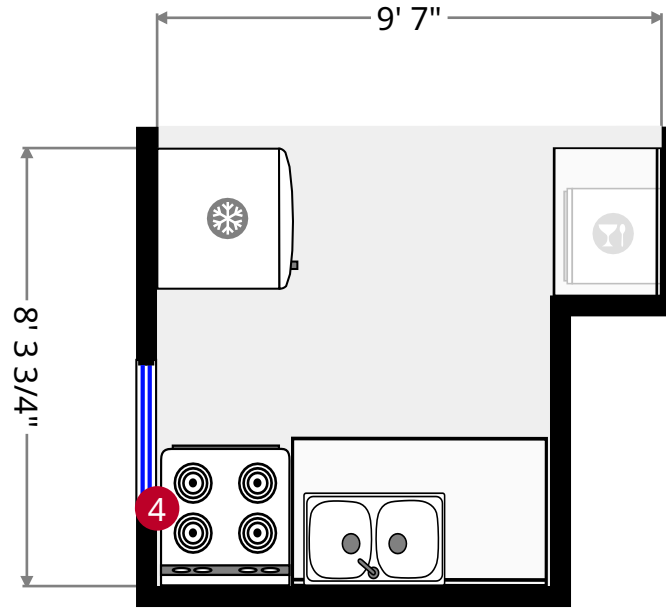
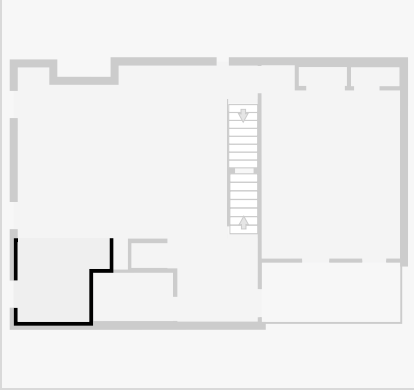

4



Hung Window

- Height: 6' 4"

THIS FLOORPLAN IS PROVIDED WITHOUT WARRANTY OF ANY KIND. NAZCA PROPERTIES DISCLAIMS ANY WARRANTY INCLUDING, WITHOUT LIMITATION, SATISFACTORY QUALITY OR ACCURACY OF DIMENSIONS.



## Closet

Width: 1' 6 1/2"  
Length: 2' 10 3/4"  
Area: 4.37 sq ft  
Perimeter: 8' 9 1/4"

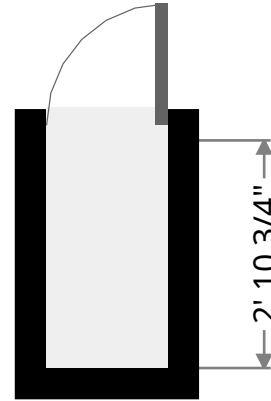
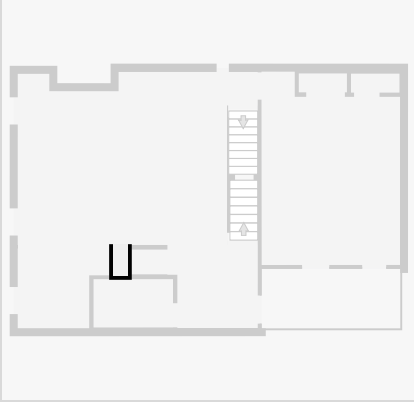

## Laundry Room

Width: 2' 6"  
Length: 3' 4"  
Area: 8.46 sq ft  
Perimeter: 11' 9"

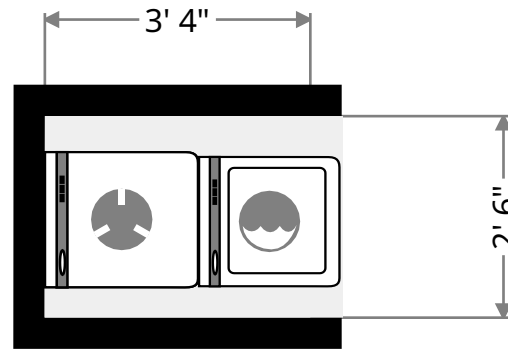
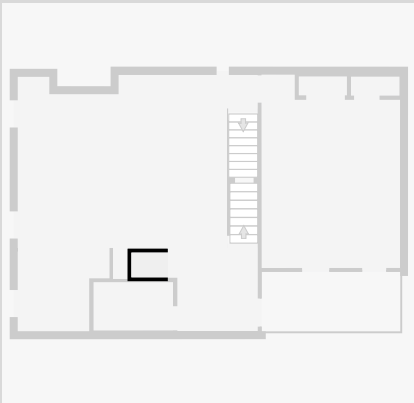

THIS FLOORPLAN IS PROVIDED WITHOUT WARRANTY OF ANY KIND. NAZCA PROPERTIES  
DISCLAIMS ANY WARRANTY INCLUDING, WITHOUT LIMITATION, SATISFACTORY QUALITY OR  
ACCURACY OF DIMENSIONS.

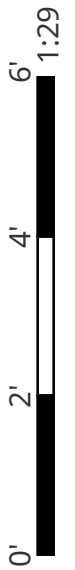

# Bathroom

Width: 4' 11"  
Length: 8' 1 3/4"  
Area: 40.23 sq ft  
Perimeter: 26' 2"  
Ceiling Height: 8'

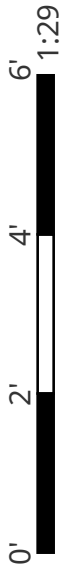
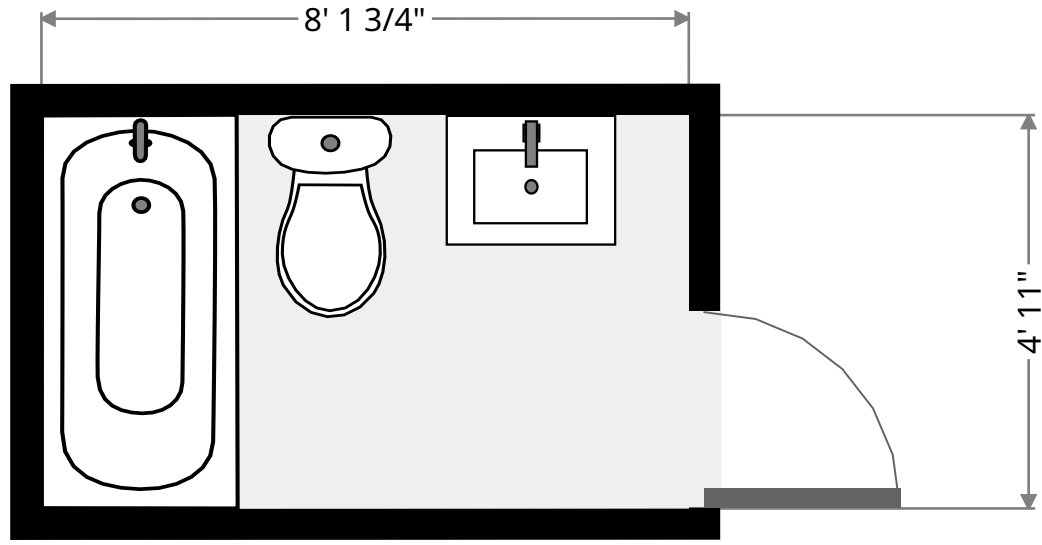
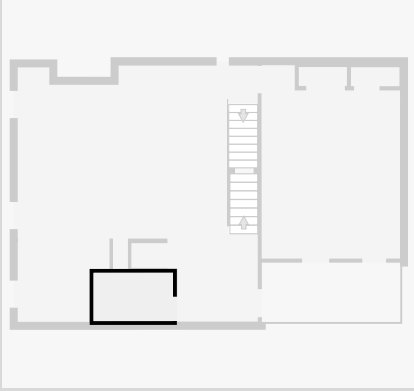

1:29

THIS FLOORPLAN IS PROVIDED WITHOUT WARRANTY OF ANY KIND. NAZCA PROPERTIES  
DISCLAIMS ANY WARRANTY INCLUDING, WITHOUT LIMITATION, SATISFACTORY QUALITY OR  
ACCURACY OF DIMENSIONS.

# Balcony

Width: 6' 1 1/4"  
 Length: 14' 2 1/2"  
 Area: 86.56 sq ft  
 Perimeter: 40' 7"  
 Ceiling Height: 11' 1/2"

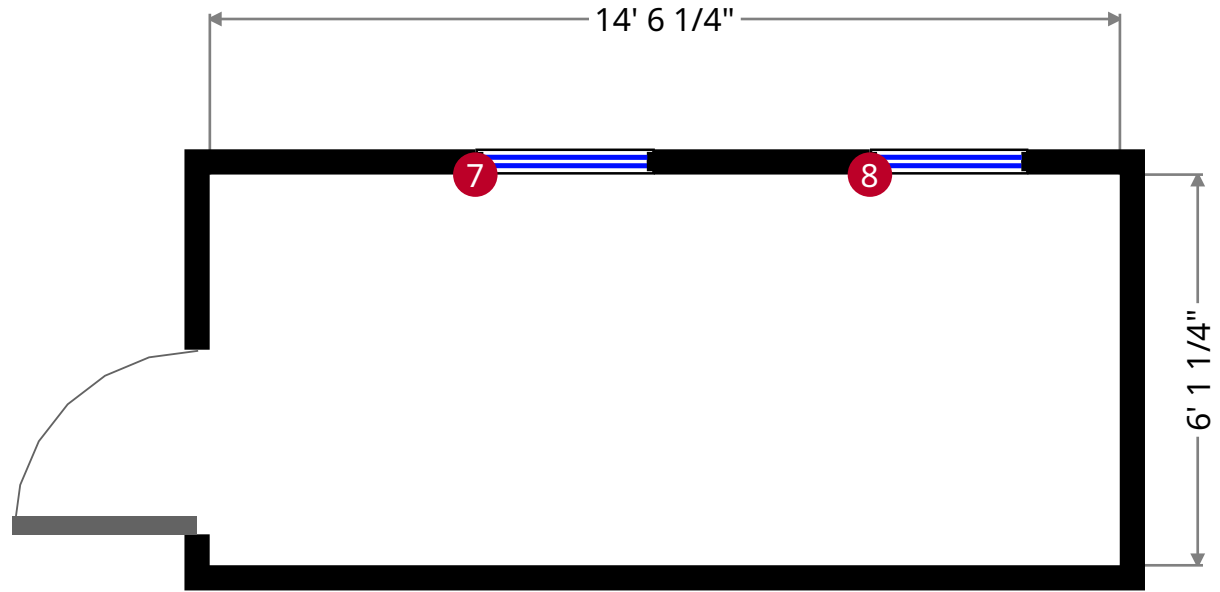
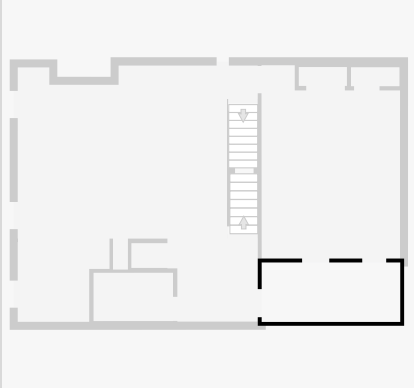

7



Hung Window

- Height: 6' 3 3/4"

8



Hung Window

- Height: 6' 3 3/4"

THIS FLOORPLAN IS PROVIDED WITHOUT WARRANTY OF ANY KIND. NAZCA PROPERTIES  
 DISCLAIMS ANY WARRANTY INCLUDING, WITHOUT LIMITATION, SATISFACTORY QUALITY OR  
 ACCURACY OF DIMENSIONS.



# Bedroom

Width: 14' 1 3/4"  
Length: 19' 9 3/4"  
Area: 252.86 sq ft  
Perimeter: 67' 11 1/2"  
Ceiling Height: 9' 11 1/2"

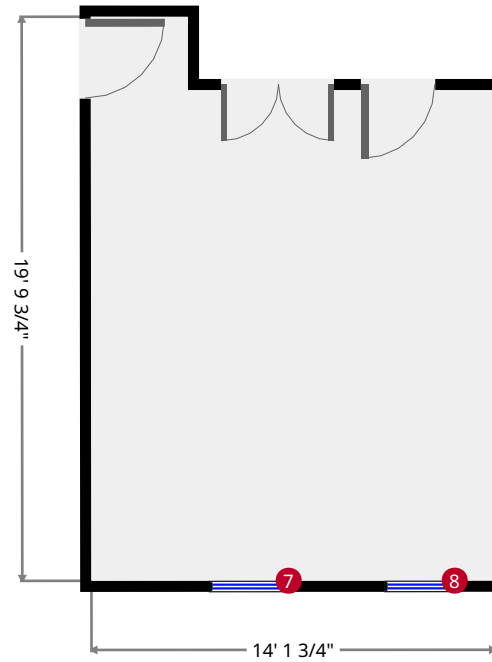
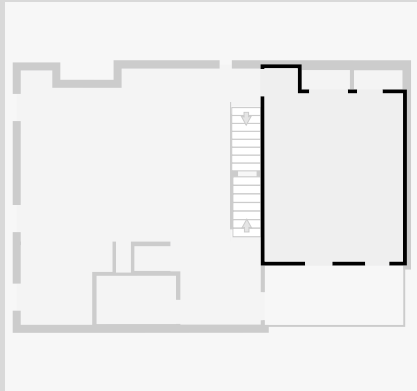

7



Hung Window

- Height: 6' 3 3/4"

8



Hung Window

- Height: 6' 3 3/4"

THIS FLOORPLAN IS PROVIDED WITHOUT WARRANTY OF ANY KIND. NAZCA PROPERTIES  
DISCLAIMS ANY WARRANTY INCLUDING, WITHOUT LIMITATION, SATISFACTORY QUALITY OR  
ACCURACY OF DIMENSIONS.



## Closet

Width: 1' 11"  
Length: 4' 11 1/4"  
Area: 9.54 sq ft  
Perimeter: 13' 8 3/4"

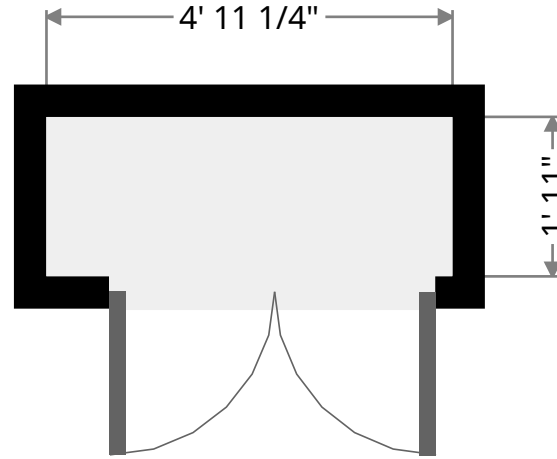
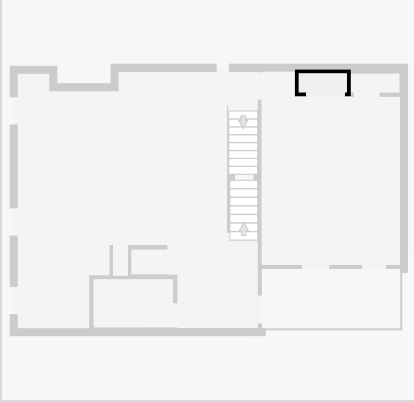

## Closet

Width: 1' 11 1/4"  
Length: 4' 11 1/2"  
Area: 9.63 sq ft  
Perimeter: 13' 9 3/4"

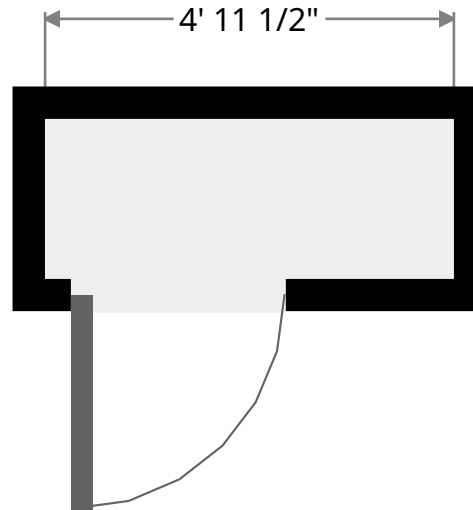
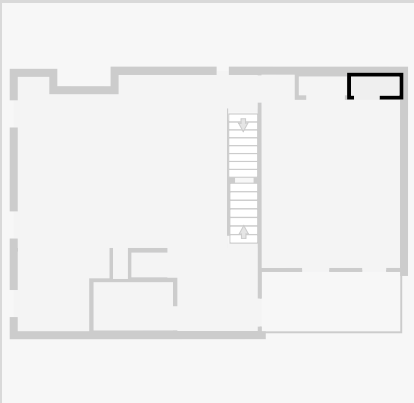

THIS FLOORPLAN IS PROVIDED WITHOUT WARRANTY OF ANY KIND. NAZCA PROPERTIES  
DISCLAIMS ANY WARRANTY INCLUDING, WITHOUT LIMITATION, SATISFACTORY QUALITY OR  
ACCURACY OF DIMENSIONS.

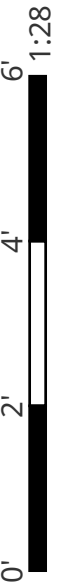



**2385 Vine St.  
Apt. 2**



2385 Vine Street, Cincinnati, Ohio, USA 45219



**Nazca Properties**  
manager@nazcaproperties.com  
513-535-2154

**Statistics**

Area: 1546 sq ft  
2 Floors  
3 Bedrooms  
2 Bathrooms

**3rd Floor**

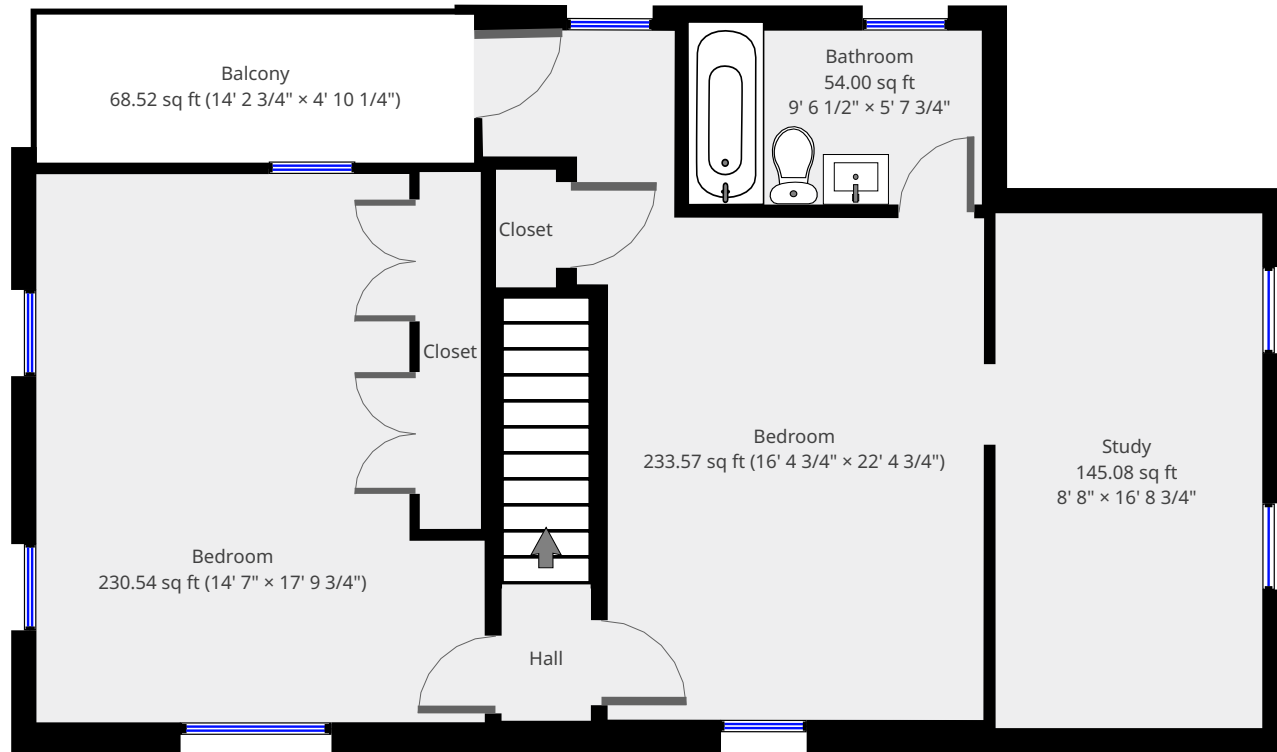

THIS FLOORPLAN IS PROVIDED WITHOUT WARRANTY OF ANY KIND. NAZCA PROPERTIES  
DISCLAIMS ANY WARRANTY INCLUDING, WITHOUT LIMITATION, SATISFACTORY QUALITY OR  
ACCURACY OF DIMENSIONS.



# Hall

Width: 2' 10 3/4"  
Length: 4' 3 3/4"  
Area: 12.48 sq ft  
Perimeter: 14' 4 3/4"  
Ceiling Height: 7' 11 3/4"

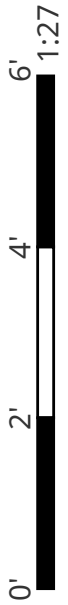
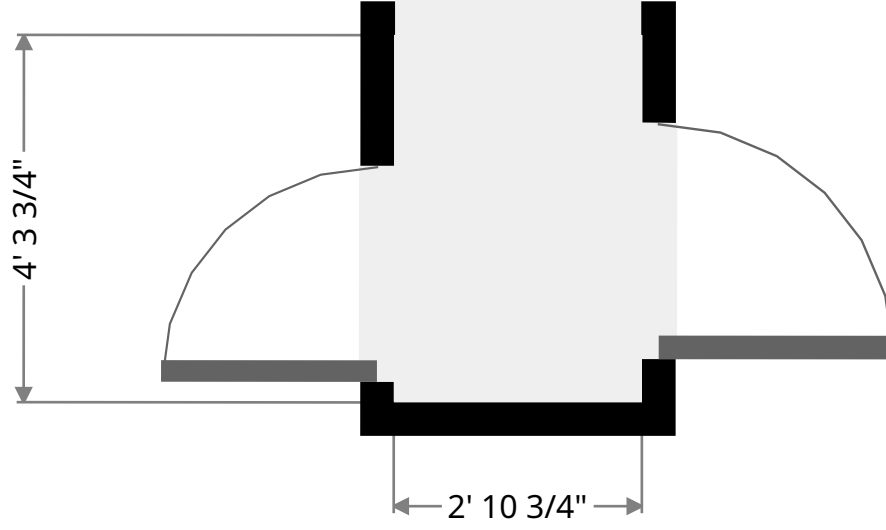
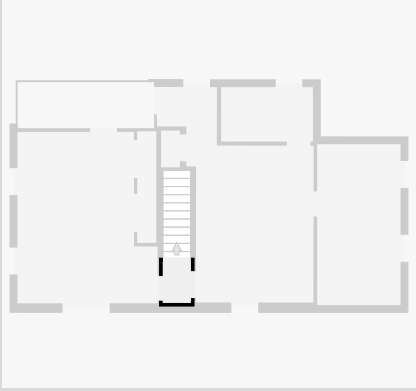

THIS FLOORPLAN IS PROVIDED WITHOUT WARRANTY OF ANY KIND. NAZCA PROPERTIES  
DISCLAIMS ANY WARRANTY INCLUDING, WITHOUT LIMITATION, SATISFACTORY QUALITY OR  
ACCURACY OF DIMENSIONS.

# Bedroom

Width: 14' 7"  
 Length: 17' 9 3/4"  
 Area: 230.54 sq ft  
 Perimeter: 64' 9 1/2"  
 Ceiling Height: 9' 2"

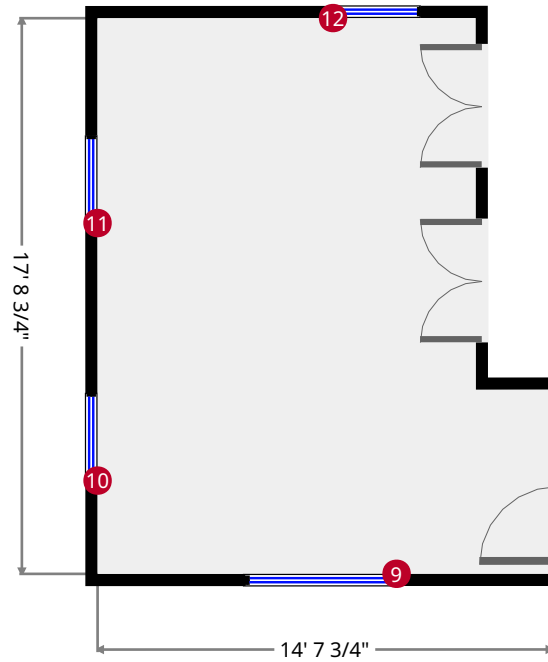
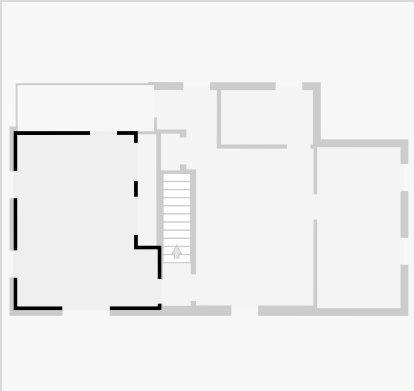

9



Hung Window

- Height: 3' 9 1/4"

10



Hung Window

- Height: 4' 8"

11



Hung Window

- Height: 4' 8"

12



Hung Window

- Height: 4' 8"

THIS FLOORPLAN IS PROVIDED WITHOUT WARRANTY OF ANY KIND. NAZCA PROPERTIES  
 DISCLAIMS ANY WARRANTY INCLUDING, WITHOUT LIMITATION, SATISFACTORY QUALITY OR  
 ACCURACY OF DIMENSIONS.



# Closet

Width: 1' 11 3/4"  
Length: 11' 7 1/4"  
Area: 23.07 sq ft  
Perimeter: 27' 2 1/4"

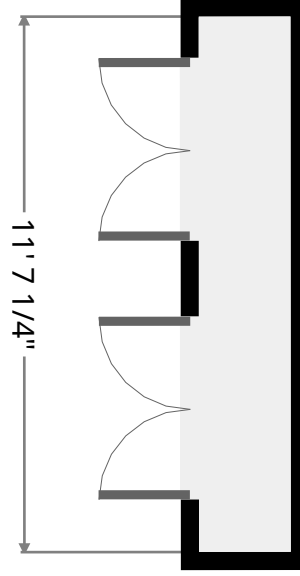
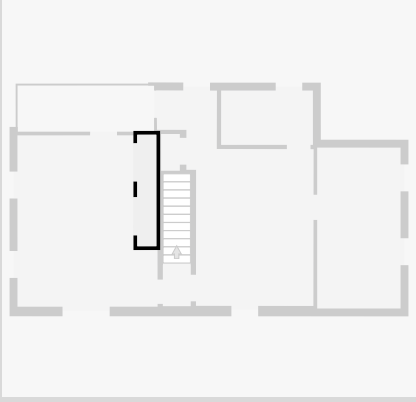

THIS FLOORPLAN IS PROVIDED WITHOUT WARRANTY OF ANY KIND. NAZCA PROPERTIES  
DISCLAIMS ANY WARRANTY INCLUDING, WITHOUT LIMITATION, SATISFACTORY QUALITY OR  
ACCURACY OF DIMENSIONS.

# Bedroom

Width: 16' 4 3/4"  
 Length: 22' 4 3/4"  
 Area: 233.57 sq ft  
 Perimeter: 77' 5 1/2"  
 Ceiling Height: 8' 1"

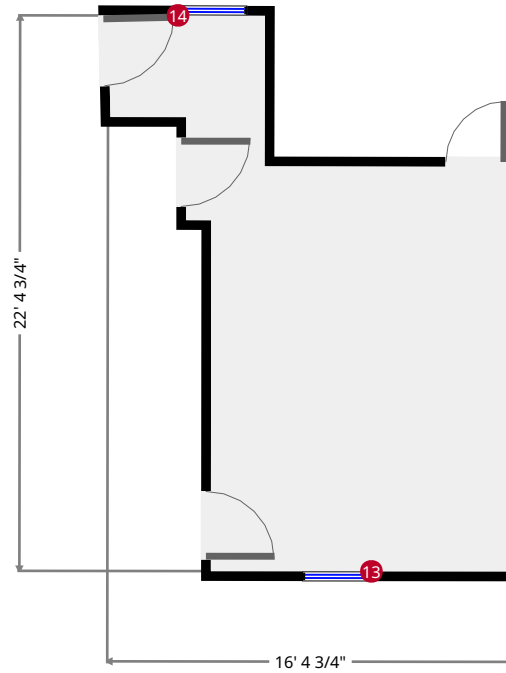
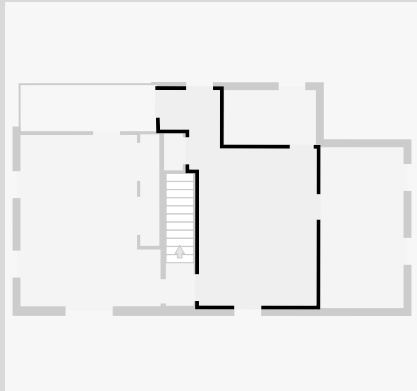

13



Hung Window

- Height: 5' 4 1/2"

14



Hung Window

- Height: 5' 4 1/2"

THIS FLOORPLAN IS PROVIDED WITHOUT WARRANTY OF ANY KIND. NAZCA PROPERTIES  
 DISCLAIMS ANY WARRANTY INCLUDING, WITHOUT LIMITATION, SATISFACTORY QUALITY OR  
 ACCURACY OF DIMENSIONS.



# Closet

Width: 1' 11 1/4"  
Length: 3' 10"  
Area: 7.46 sq ft  
Perimeter: 11' 6 1/2"

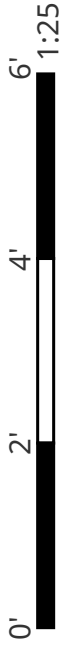
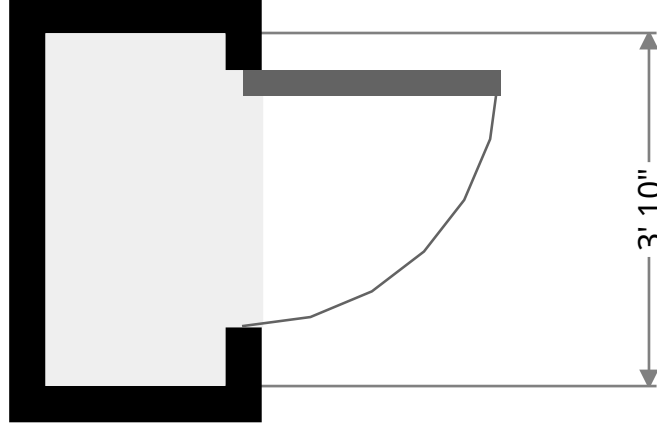
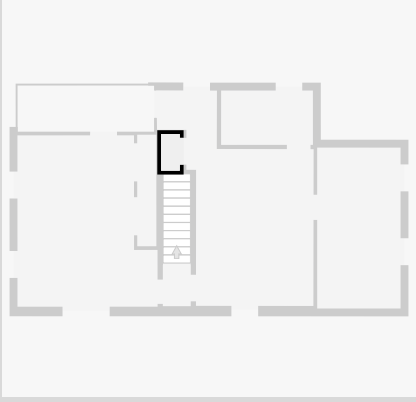

THIS FLOORPLAN IS PROVIDED WITHOUT WARRANTY OF ANY KIND. NAZCA PROPERTIES  
DISCLAIMS ANY WARRANTY INCLUDING, WITHOUT LIMITATION, SATISFACTORY QUALITY OR  
ACCURACY OF DIMENSIONS.

# Balcony

Width: 4' 10 1/4"  
Length: 14' 2 3/4"  
Area: 68.52 sq ft  
Perimeter: 38' 1"

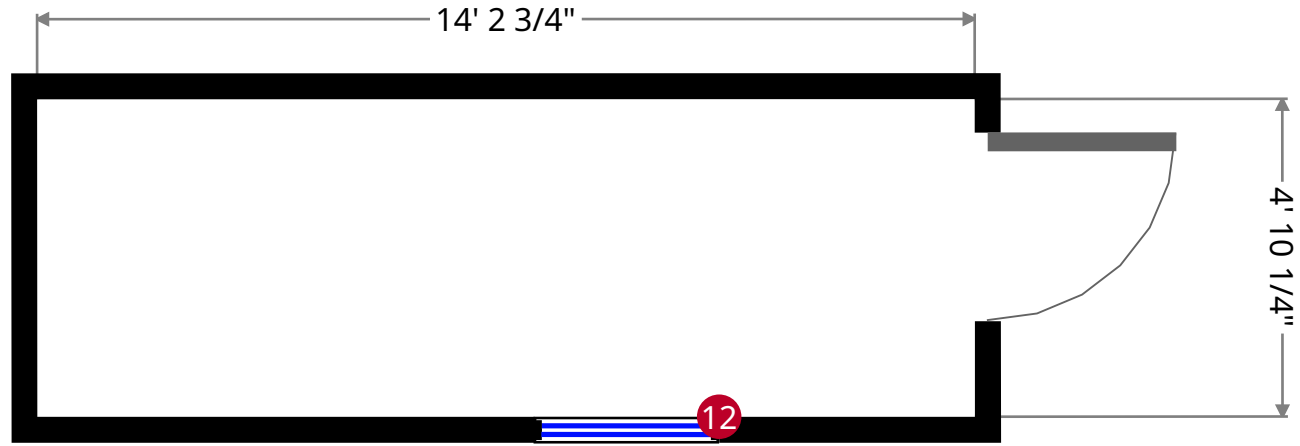
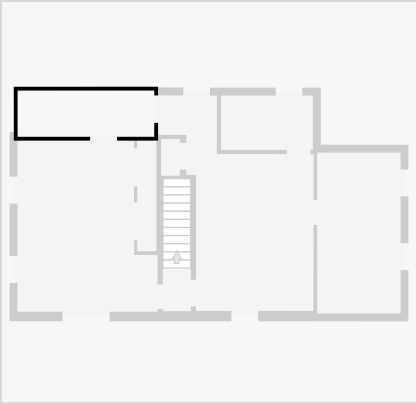

12



Hung Window

- Height: 4' 8"

THIS FLOORPLAN IS PROVIDED WITHOUT WARRANTY OF ANY KIND. NAZCA PROPERTIES  
DISCLAIMS ANY WARRANTY INCLUDING, WITHOUT LIMITATION, SATISFACTORY QUALITY OR  
ACCURACY OF DIMENSIONS.



# Study

Width: 8' 8"  
Length: 16' 8 3/4"  
Area: 145.08 sq ft  
Perimeter: 50' 9 3/4"  
Ceiling Height: 6' 8"

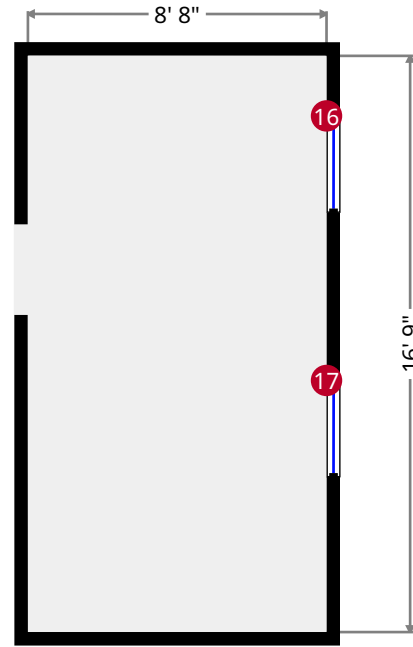
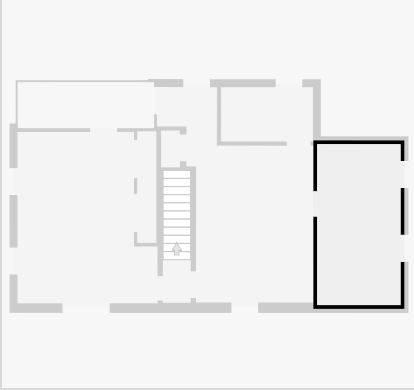

16



Fixed Window

- Height: 9"

17



Fixed Window

- Height: 9"

THIS FLOORPLAN IS PROVIDED WITHOUT WARRANTY OF ANY KIND. NAZCA PROPERTIES  
DISCLAIMS ANY WARRANTY INCLUDING, WITHOUT LIMITATION, SATISFACTORY QUALITY OR  
ACCURACY OF DIMENSIONS.





# Bathroom

Width: 5' 7 3/4"  
 Length: 9' 6 1/2"  
 Area: 54.00 sq ft  
 Perimeter: 30' 5"  
 Ceiling Height: 8'

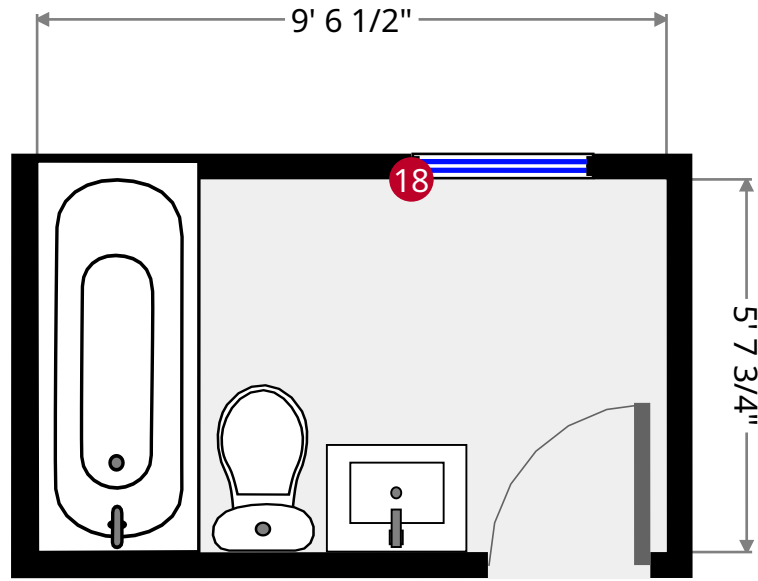
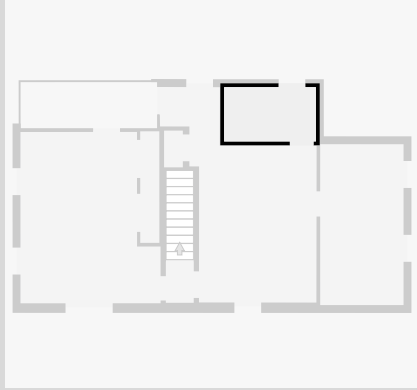

18



Hung Window

- Height: 5' 3/4"

THIS FLOORPLAN IS PROVIDED WITHOUT WARRANTY OF ANY KIND. NAZCA PROPERTIES  
 DISCLAIMS ANY WARRANTY INCLUDING, WITHOUT LIMITATION, SATISFACTORY QUALITY OR  
 ACCURACY OF DIMENSIONS.

