

2402 W.
Clifton Ave.

2nd Floor



Nazca Properties
manager@nazcaproperties.com
513-535-2154

Statistics

Area: 1234 sq ft
1 Floor
3 Bedrooms
2 Bathrooms

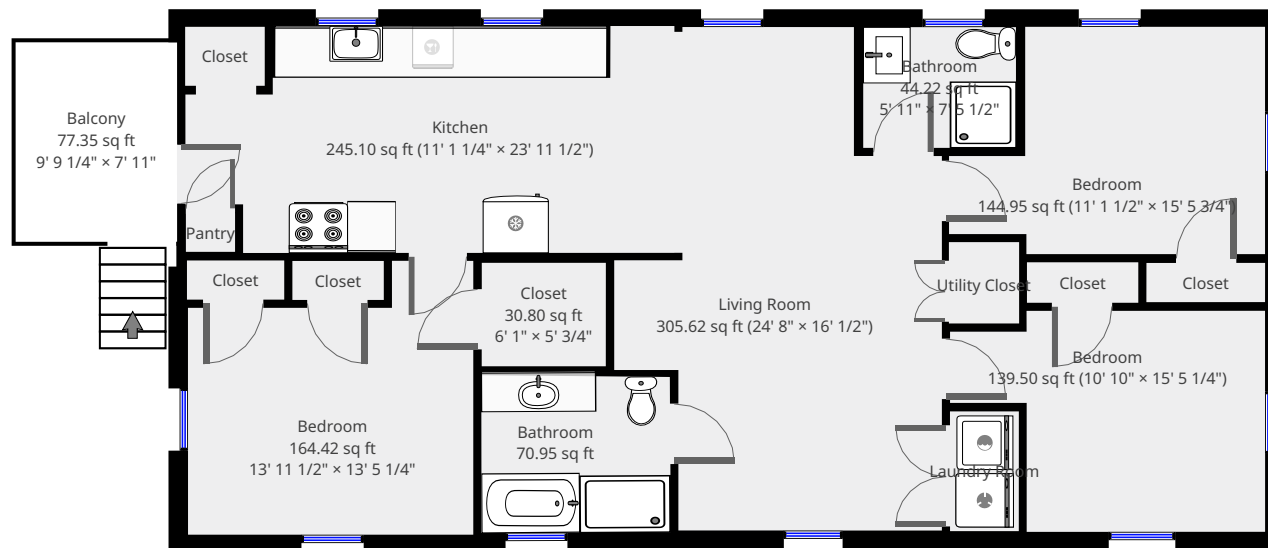

THIS FLOORPLAN IS PROVIDED WITHOUT WARRANTY OF ANY KIND. NAZCA PROPERTIES
DISCLAIMS ANY WARRANTY INCLUDING, WITHOUT LIMITATION, SATISFACTORY QUALITY OR
ACCURACY OF DIMENSIONS.

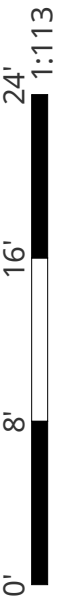

Living Room

Width: 16' 1/2"
Length: 24' 8"
Area: 305.62 sq ft
Perimeter: 81' 5"

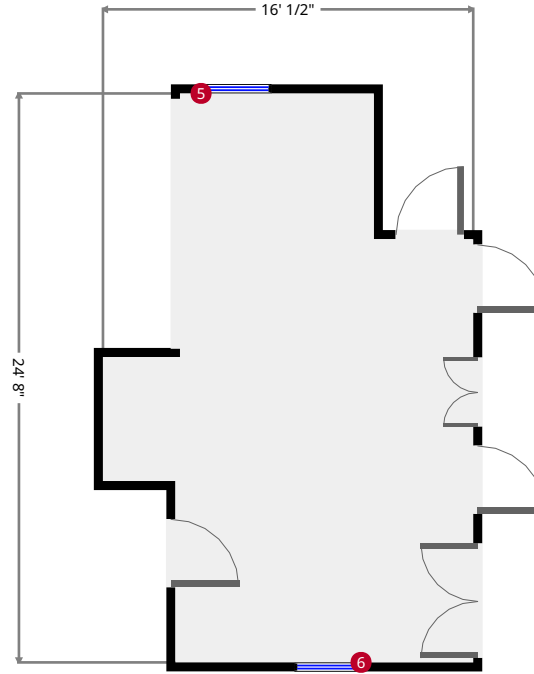
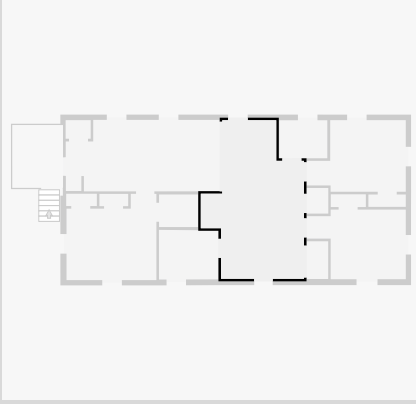

5



Hung Window

- Height: 5' 1 1/2"

6



Hung Window

- Height: 5' 1 1/2"

THIS FLOORPLAN IS PROVIDED WITHOUT WARRANTY OF ANY KIND. NAZCA PROPERTIES
DISCLAIMS ANY WARRANTY INCLUDING, WITHOUT LIMITATION, SATISFACTORY QUALITY OR
ACCURACY OF DIMENSIONS.



Bathroom

Width: 7' 8 3/4"
 Length: 9' 2 3/4"
 Area: 70.95 sq ft
 Perimeter: 33' 10"

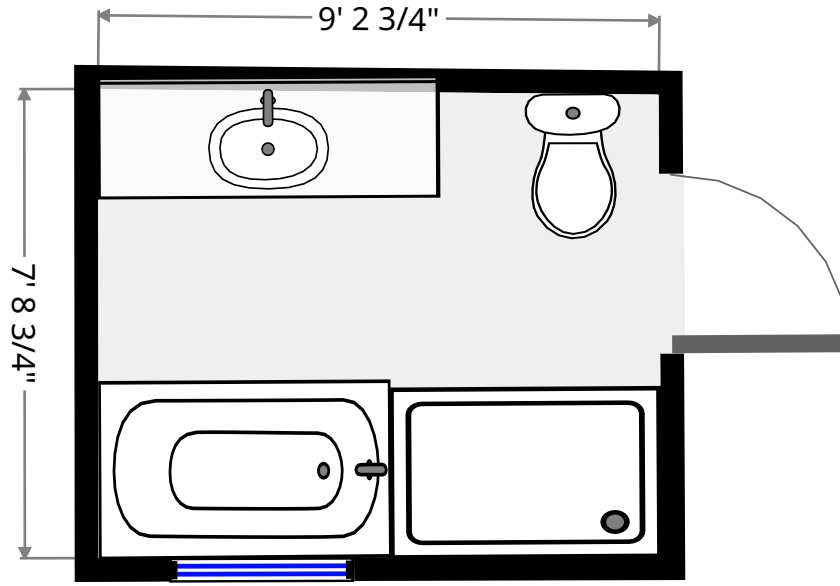
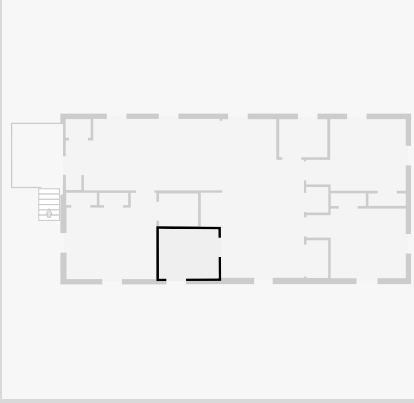

Laundry Room

Width: 3' 4 1/2"
 Length: 5' 10 1/2"
 Area: 19.77 sq ft
 Perimeter: 18' 5 3/4"

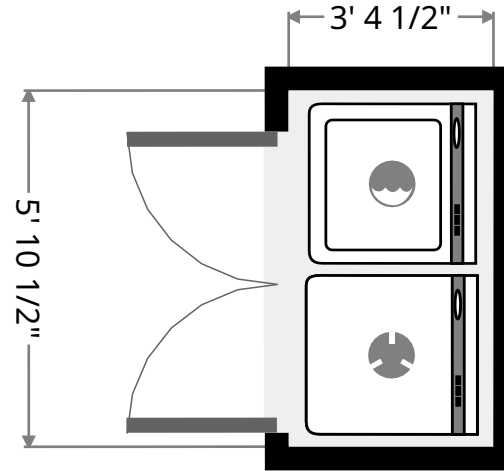
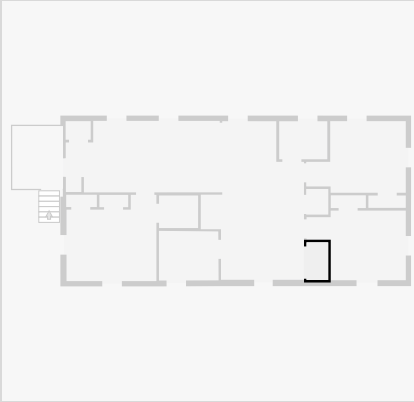

THIS FLOORPLAN IS PROVIDED WITHOUT WARRANTY OF ANY KIND. NAZCA PROPERTIES
 DISCLAIMS ANY WARRANTY INCLUDING, WITHOUT LIMITATION, SATISFACTORY QUALITY OR
 ACCURACY OF DIMENSIONS.

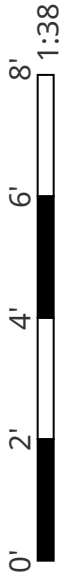

Closet

Width: 1' 11 3/4"
Length: 5' 5 1/2"
Area: 10.81 sq ft
Perimeter: 14' 10 1/2"

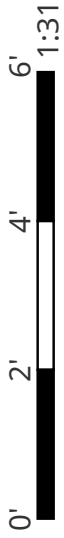
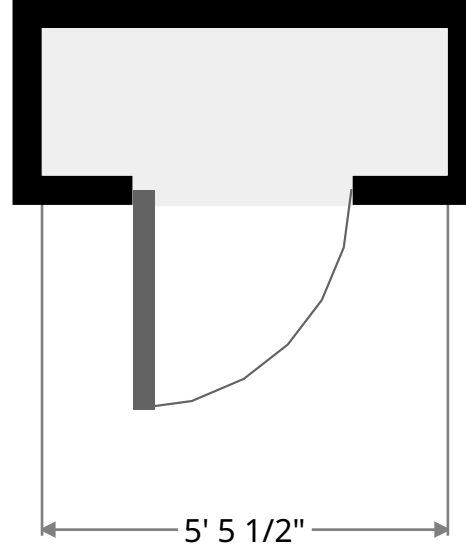
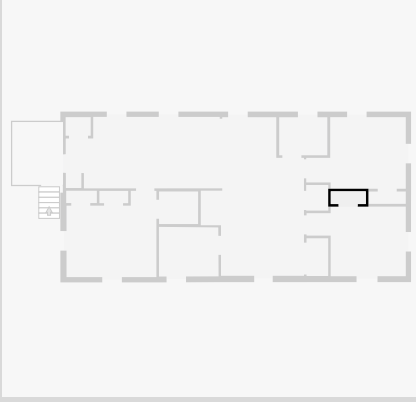

THIS FLOORPLAN IS PROVIDED WITHOUT WARRANTY OF ANY KIND. NAZCA PROPERTIES
DISCLAIMS ANY WARRANTY INCLUDING, WITHOUT LIMITATION, SATISFACTORY QUALITY OR
ACCURACY OF DIMENSIONS.

Bedroom

Width: 10' 10"
 Length: 15' 5 1/4"
 Area: 139.50 sq ft
 Perimeter: 52' 6 1/4"

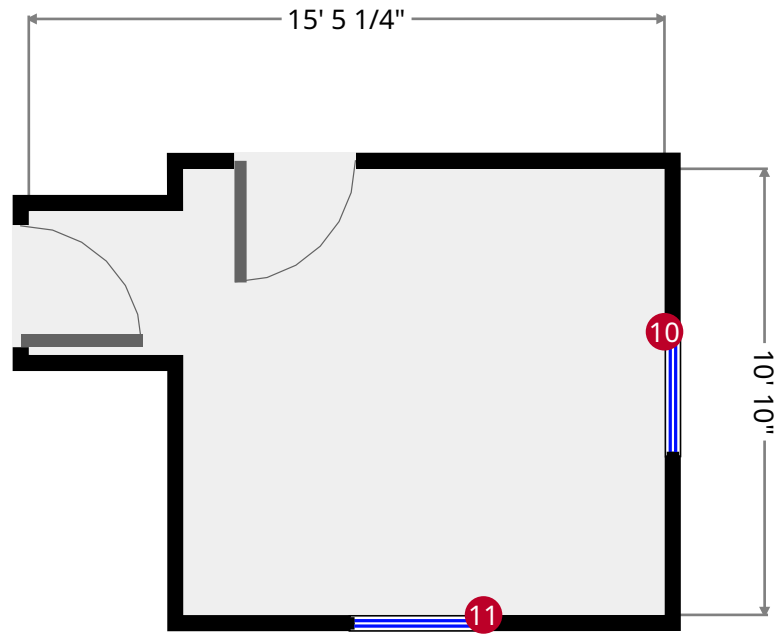
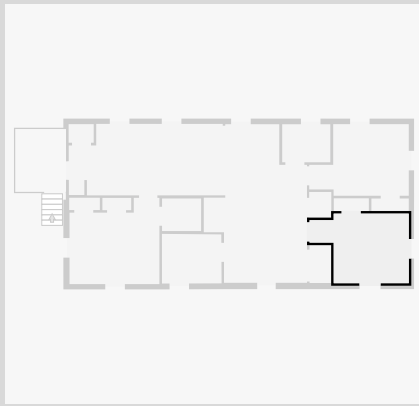

10



Hung Window

- Height: 4' 11 1/4"

11



Hung Window

- Height: 4' 11 1/4"

THIS FLOORPLAN IS PROVIDED WITHOUT WARRANTY OF ANY KIND. NAZCA PROPERTIES
 DISCLAIMS ANY WARRANTY INCLUDING, WITHOUT LIMITATION, SATISFACTORY QUALITY OR
 ACCURACY OF DIMENSIONS.

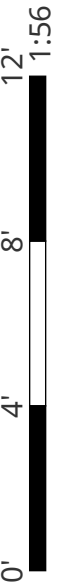

Utility Closet

Width: 3' 5 1/2"
Length: 3' 11 3/4"
Area: 13.69 sq ft
Perimeter: 14' 10"

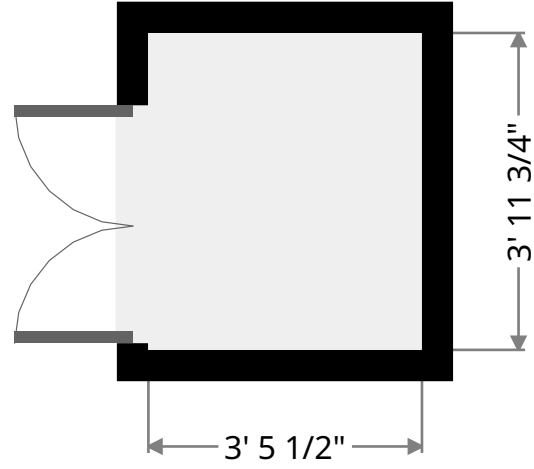
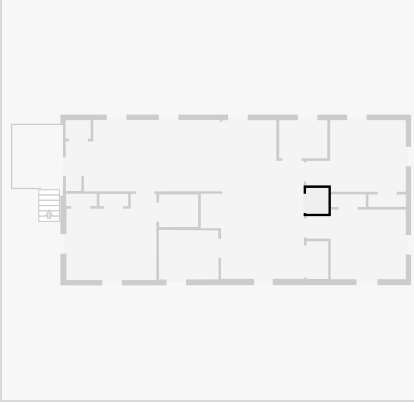

Closet

Width: 1' 11"
Length: 5' 9 3/4"
Area: 11.15 sq ft
Perimeter: 15' 5 1/2"

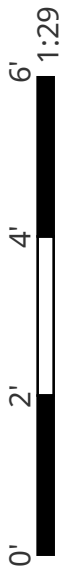
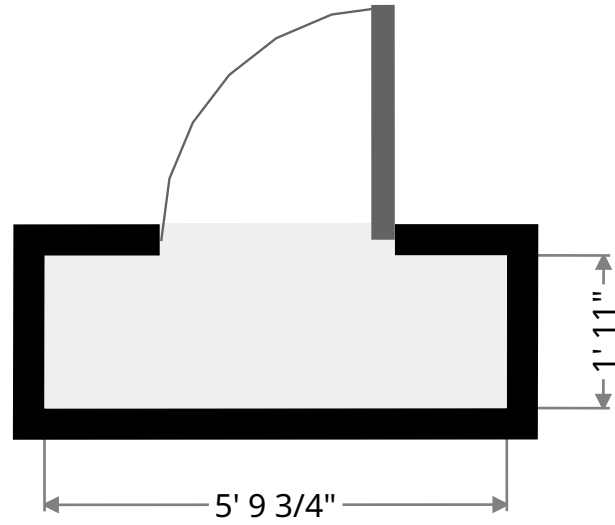
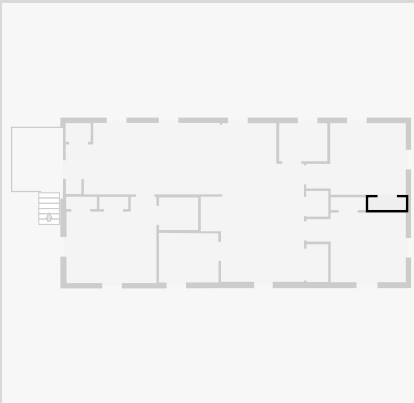

THIS FLOORPLAN IS PROVIDED WITHOUT WARRANTY OF ANY KIND. NAZCA PROPERTIES
DISCLAIMS ANY WARRANTY INCLUDING, WITHOUT LIMITATION, SATISFACTORY QUALITY OR
ACCURACY OF DIMENSIONS.

Bedroom

Width: 11' 1 1/2"
Length: 15' 5 3/4"
Area: 144.95 sq ft
Perimeter: 53' 2 1/2"

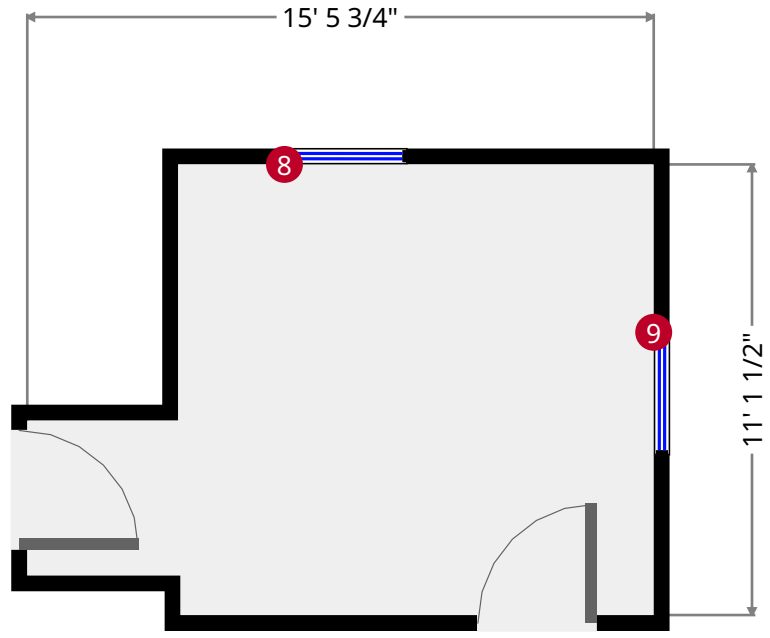
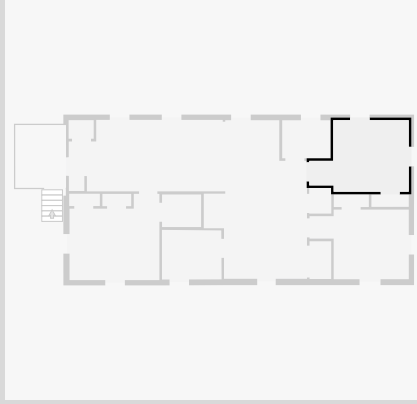

8



Hung Window

- Height: 5' 1"

9



Hung Window

- Height: 5' 1"

THIS FLOORPLAN IS PROVIDED WITHOUT WARRANTY OF ANY KIND. NAZCA PROPERTIES
DISCLAIMS ANY WARRANTY INCLUDING, WITHOUT LIMITATION, SATISFACTORY QUALITY OR
ACCURACY OF DIMENSIONS.



Bathroom

Width: 5' 11"
Length: 7' 5 1/2"
Area: 44.22 sq ft
Perimeter: 26' 9 1/2"

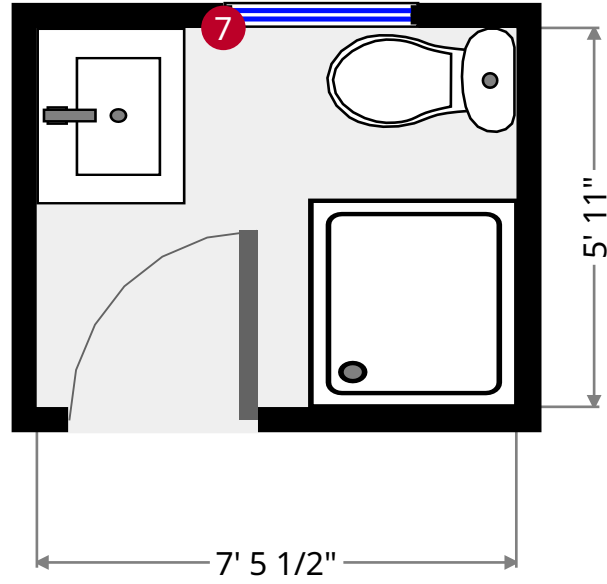
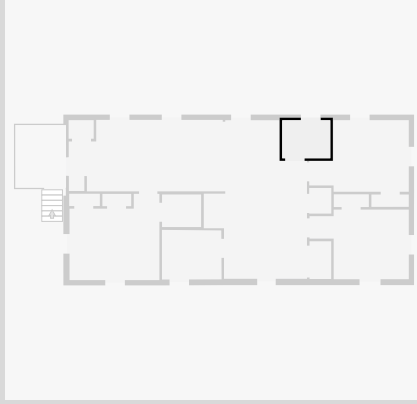

7



Hung Window

- Height: 3' 9 1/4"

THIS FLOORPLAN IS PROVIDED WITHOUT WARRANTY OF ANY KIND. NAZCA PROPERTIES
DISCLAIMS ANY WARRANTY INCLUDING, WITHOUT LIMITATION, SATISFACTORY QUALITY OR
ACCURACY OF DIMENSIONS.



Kitchen

Width: 11' 1 1/4"
 Length: 23' 11 1/2"
 Area: 245.10 sq ft
 Perimeter: 70' 1 1/2"

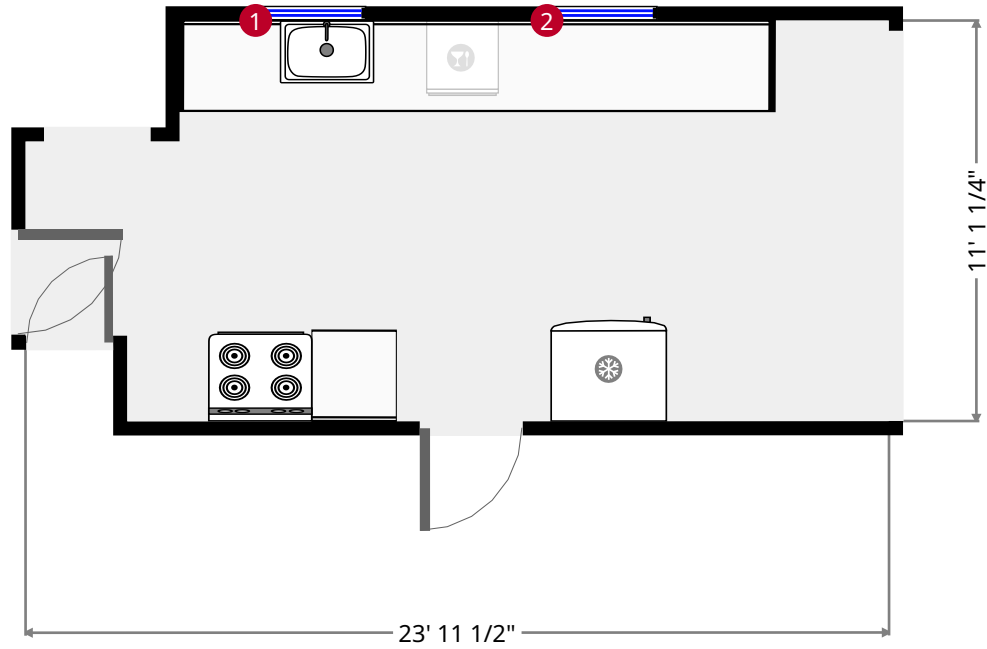
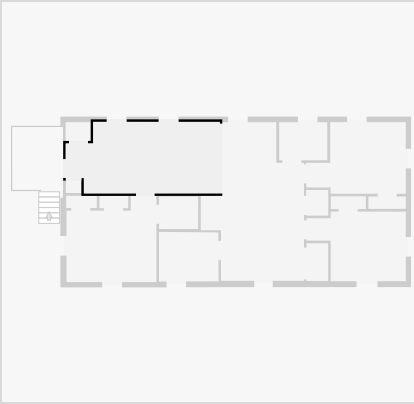

1



Hung Window

- Height: 3' 8"

2



Hung Window

- Height: 3' 8"

THIS FLOORPLAN IS PROVIDED WITHOUT WARRANTY OF ANY KIND. NAZCA PROPERTIES
 DISCLAIMS ANY WARRANTY INCLUDING, WITHOUT LIMITATION, SATISFACTORY QUALITY OR
 ACCURACY OF DIMENSIONS.

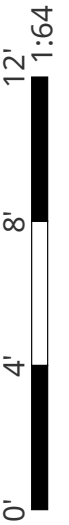

Closet

Width: 5' 3/4"
Length: 6' 1"
Area: 30.80 sq ft
Perimeter: 22' 3 1/2"

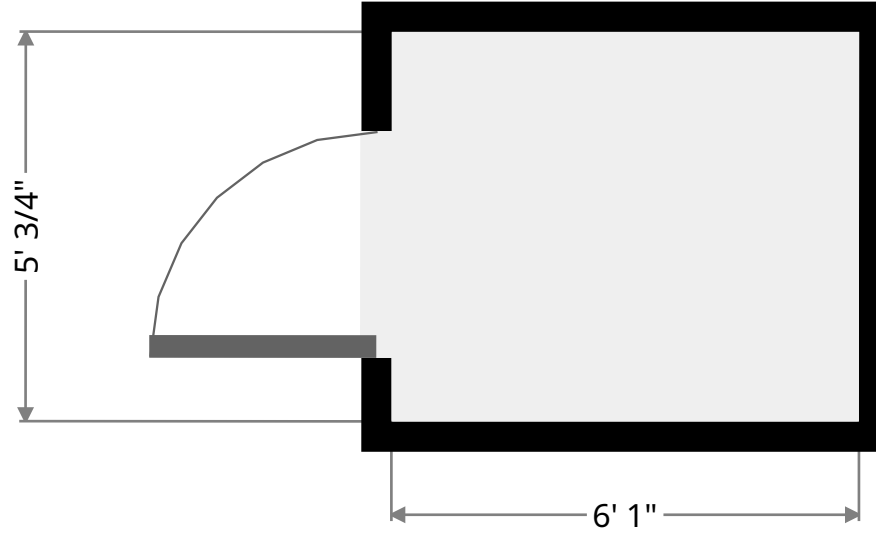
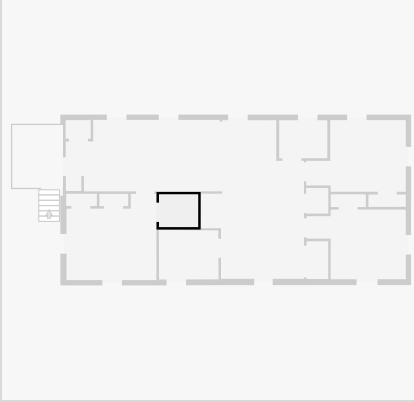

Closet

Width: 1' 11"
Length: 4' 5 3/4"
Area: 8.54 sq ft
Perimeter: 12' 9 1/4"

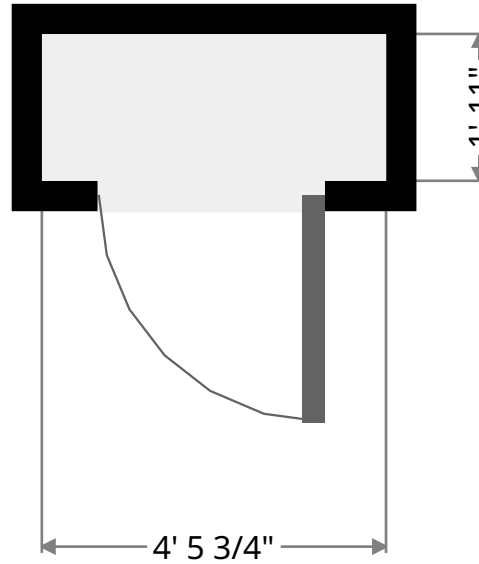
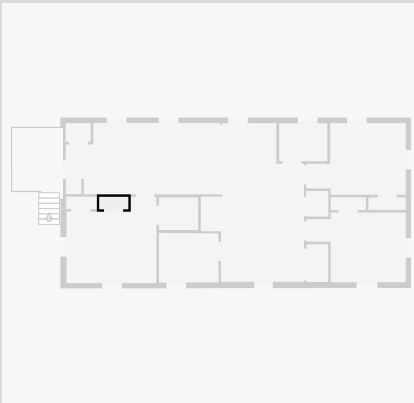

THIS FLOORPLAN IS PROVIDED WITHOUT WARRANTY OF ANY KIND. NAZCA PROPERTIES
DISCLAIMS ANY WARRANTY INCLUDING, WITHOUT LIMITATION, SATISFACTORY QUALITY OR
ACCURACY OF DIMENSIONS.

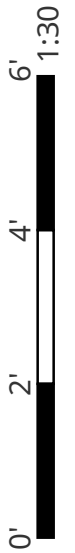

Closet

Width: 1' 11"
Length: 4' 9 1/4"
Area: 9.13 sq ft
Perimeter: 13' 4 1/4"

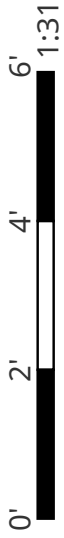
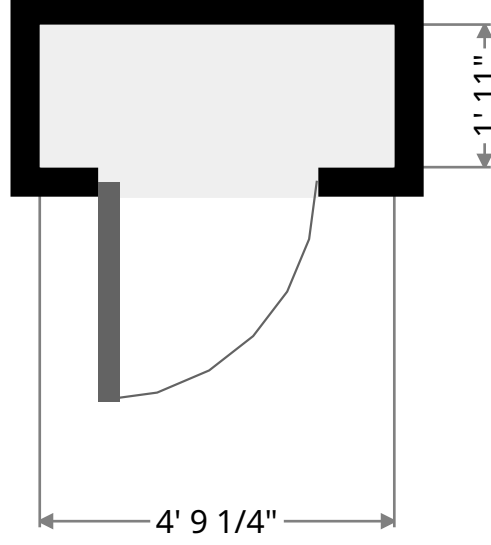
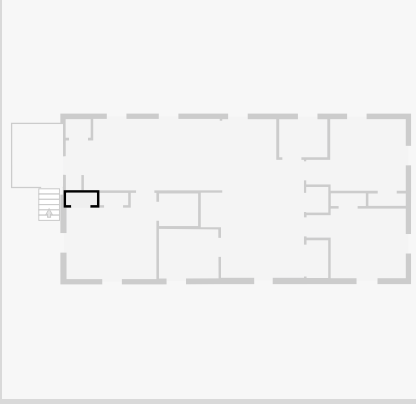

THIS FLOORPLAN IS PROVIDED WITHOUT WARRANTY OF ANY KIND. NAZCA PROPERTIES
DISCLAIMS ANY WARRANTY INCLUDING, WITHOUT LIMITATION, SATISFACTORY QUALITY OR
ACCURACY OF DIMENSIONS.

Bedroom

Width: 13' 5 1/4"
 Length: 13' 11 1/2"
 Area: 164.42 sq ft
 Perimeter: 54' 9 1/4"

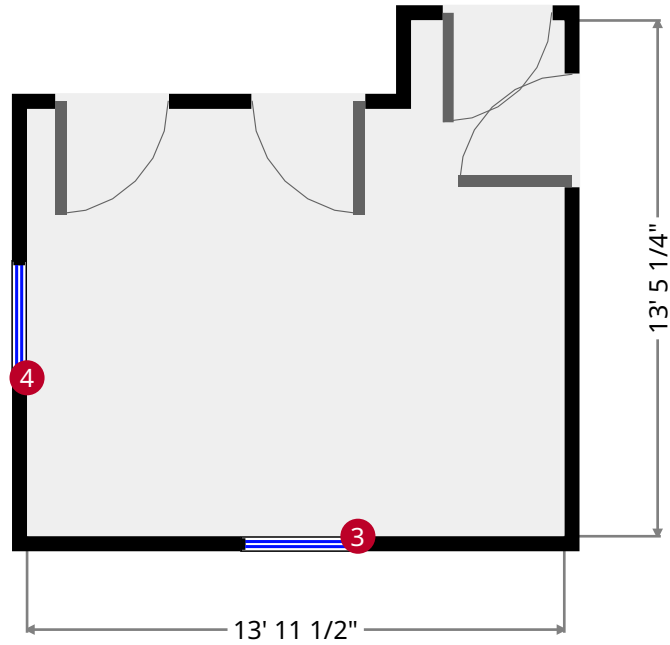
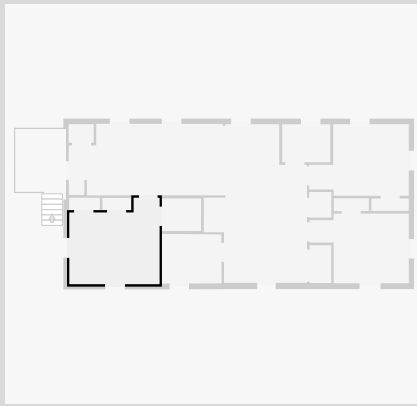

3



Hung Window

- Height: 5' 3/4"

4



Hung Window

- Height: 5' 3/4"

THIS FLOORPLAN IS PROVIDED WITHOUT WARRANTY OF ANY KIND. NAZCA PROPERTIES
 DISCLAIMS ANY WARRANTY INCLUDING, WITHOUT LIMITATION, SATISFACTORY QUALITY OR
 ACCURACY OF DIMENSIONS.

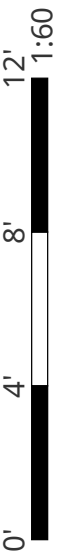

Balcony

Width: 7' 11"
Length: 9' 9 1/4"
Area: 77.35 sq ft
Perimeter: 35' 4 1/2"

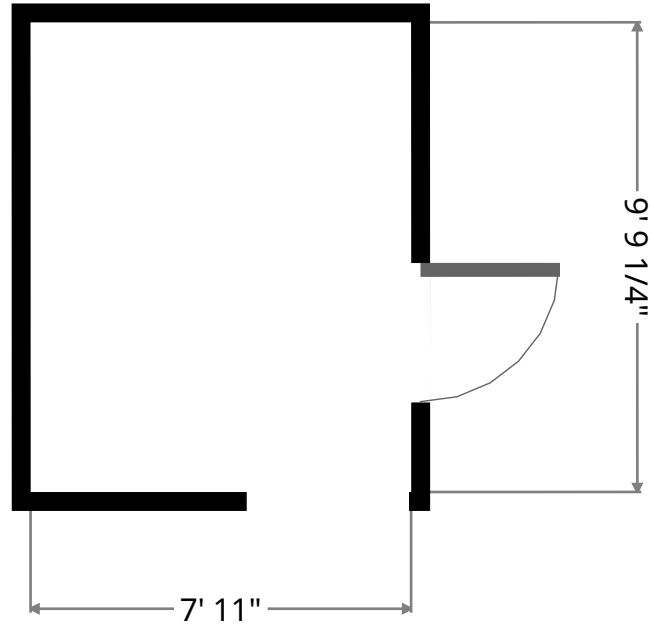
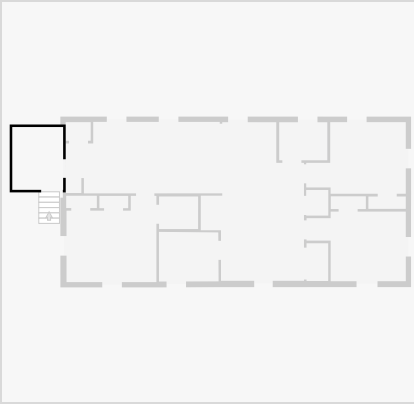

Pantry

Width: 1' 10 3/4"
Length: 2' 5"
Area: 4.55 sq ft
Perimeter: 8' 7 1/4"

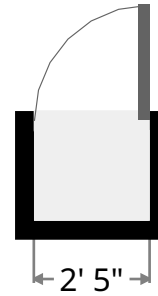
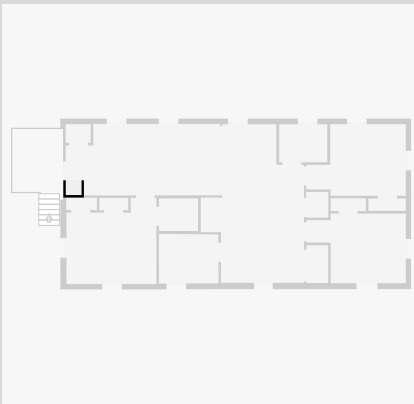

THIS FLOORPLAN IS PROVIDED WITHOUT WARRANTY OF ANY KIND. NAZCA PROPERTIES
DISCLAIMS ANY WARRANTY INCLUDING, WITHOUT LIMITATION, SATISFACTORY QUALITY OR
ACCURACY OF DIMENSIONS.

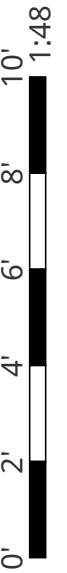

Closet

Width: 2' 10 3/4"
Length: 3' 10 3/4"
Area: 11.25 sq ft
Perimeter: 13' 6 3/4"

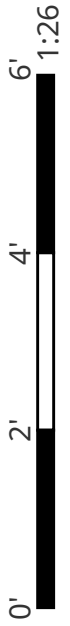
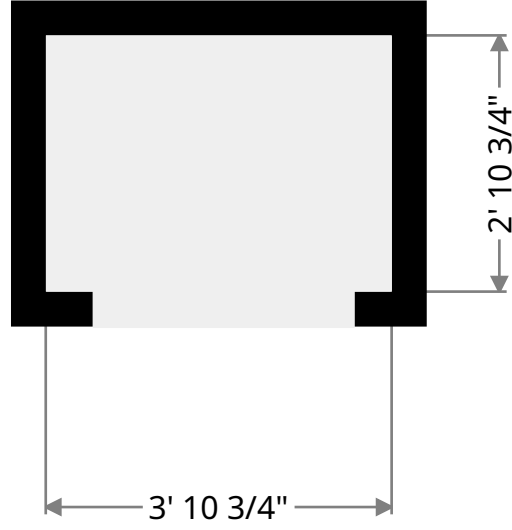
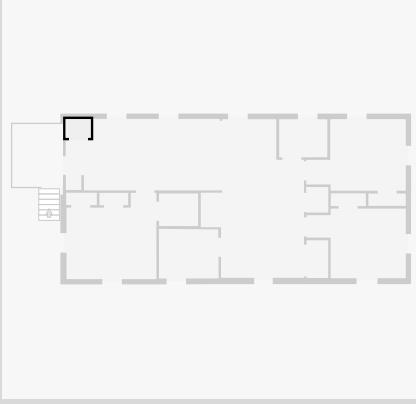

THIS FLOORPLAN IS PROVIDED WITHOUT WARRANTY OF ANY KIND. NAZCA PROPERTIES
DISCLAIMS ANY WARRANTY INCLUDING, WITHOUT LIMITATION, SATISFACTORY QUALITY OR
ACCURACY OF DIMENSIONS.