

**2404 W.  
Clifton Apt. 1**

1st Floor



**Nazca Properties**  
manager@nazcaproperties.com  
513-535-2154

**Statistics**

Area: 1108 sq ft  
1 Floor  
3 Bedrooms  
1 Bathroom

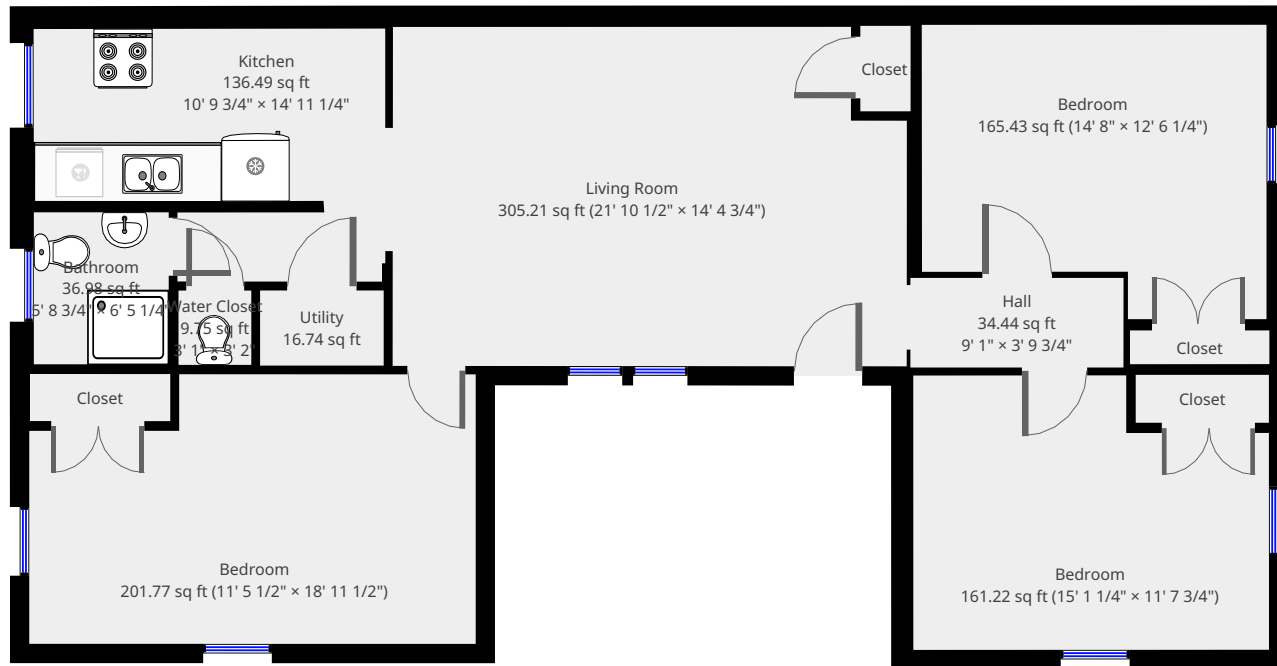

THIS FLOORPLAN IS PROVIDED WITHOUT WARRANTY OF ANY KIND. NAZCA PROPERTIES  
DISCLAIMS ANY WARRANTY INCLUDING, WITHOUT LIMITATION, SATISFACTORY QUALITY OR  
ACCURACY OF DIMENSIONS.

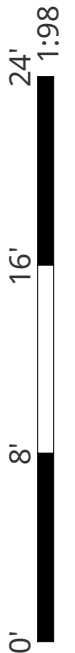

# Living Room

Width: 14' 4 3/4"  
Length: 21' 10 1/2"  
Area: 305.21 sq ft  
Perimeter: 72' 6"

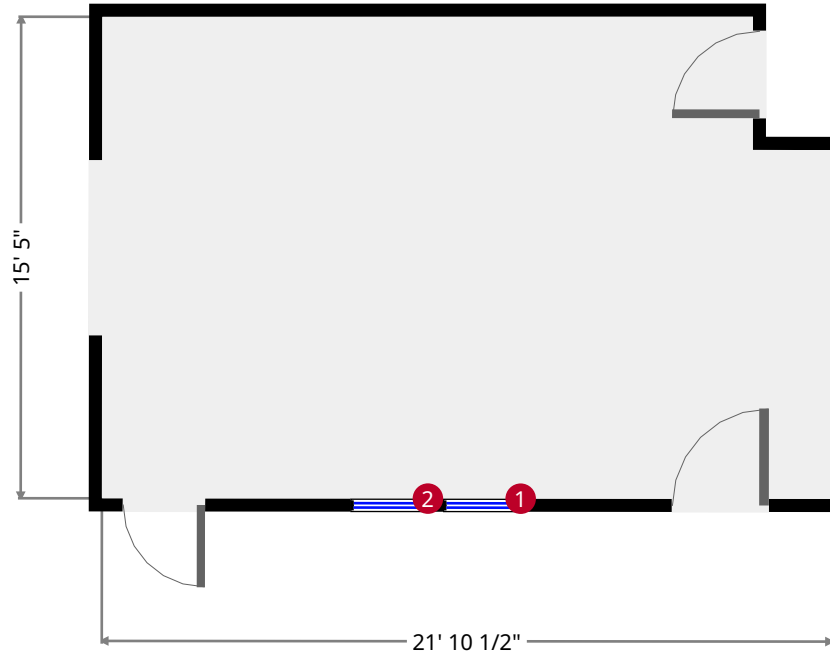
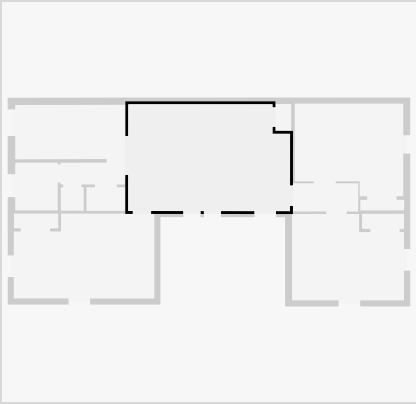

1



Hung Window

- Height: 6' 3 3/4"

2



Hung Window

- Height: 6' 3 3/4"

THIS FLOORPLAN IS PROVIDED WITHOUT WARRANTY OF ANY KIND. NAZCA PROPERTIES  
DISCLAIMS ANY WARRANTY INCLUDING, WITHOUT LIMITATION, SATISFACTORY QUALITY OR  
ACCURACY OF DIMENSIONS.



# Closet

Width: 2' 1 1/2"  
Length: 3' 7 1/2"  
Area: 7.74 sq ft  
Perimeter: 11' 6 1/4"

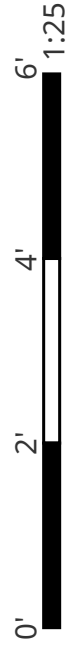
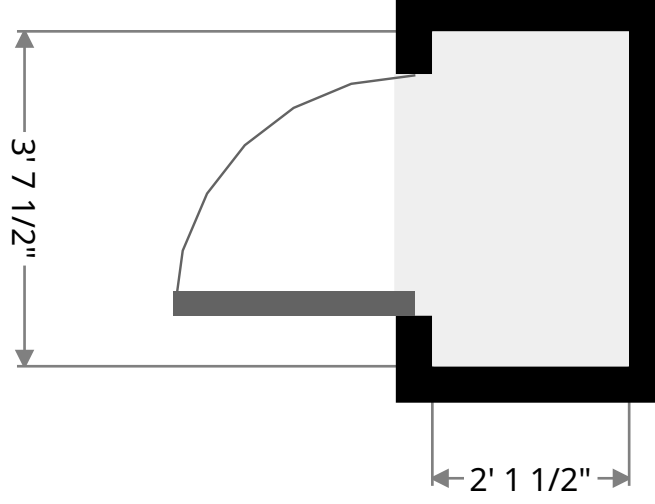
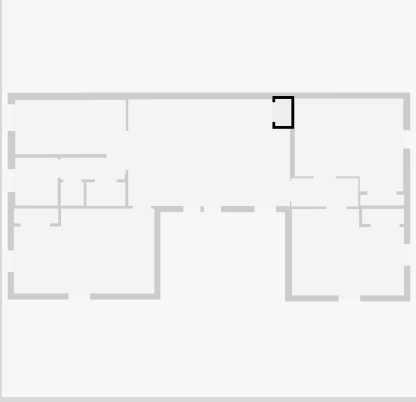

THIS FLOORPLAN IS PROVIDED WITHOUT WARRANTY OF ANY KIND. NAZCA PROPERTIES  
DISCLAIMS ANY WARRANTY INCLUDING, WITHOUT LIMITATION, SATISFACTORY QUALITY OR  
ACCURACY OF DIMENSIONS.

# Bedroom

Width: 11' 5 1/2"  
Length: 18' 11 1/2"  
Area: 201.77 sq ft  
Perimeter: 60' 9 3/4"

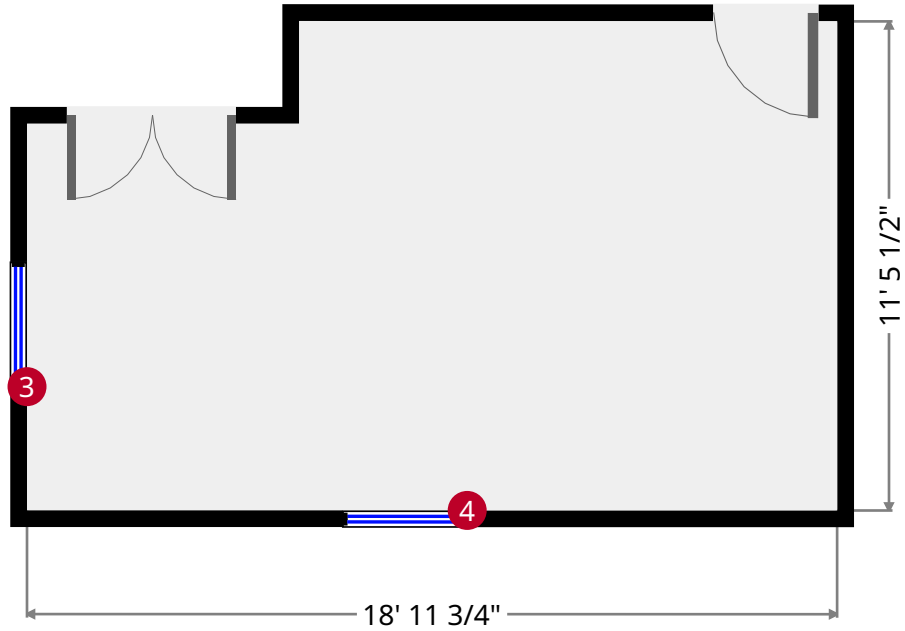
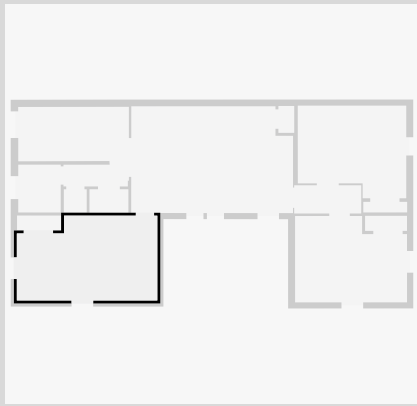

3



Hung Window

- Height: 5' 11 1/4"

4



Hung Window

- Height: 5' 11 1/4"

THIS FLOORPLAN IS PROVIDED WITHOUT WARRANTY OF ANY KIND. NAZCA PROPERTIES  
DISCLAIMS ANY WARRANTY INCLUDING, WITHOUT LIMITATION, SATISFACTORY QUALITY OR  
ACCURACY OF DIMENSIONS.

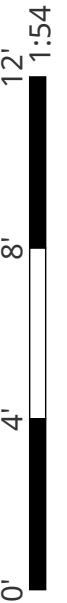

# Closet

Width: 2'  
Length: 5' 11 1/2"  
Area: 11.90 sq ft  
Perimeter: 15' 11"

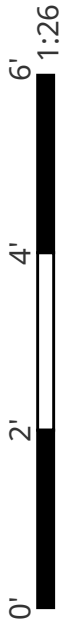
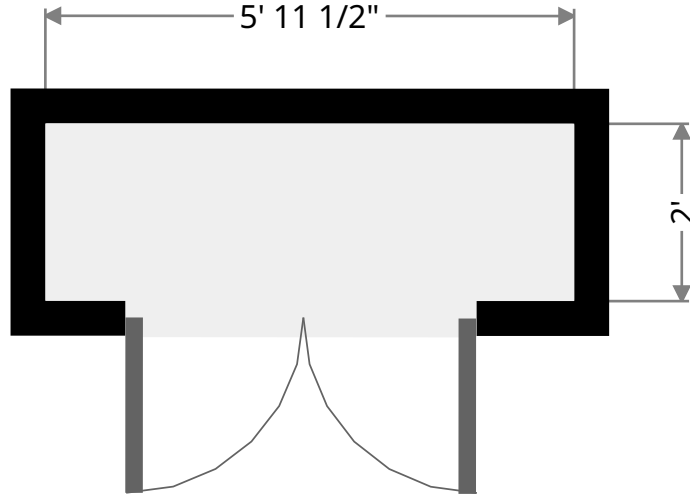
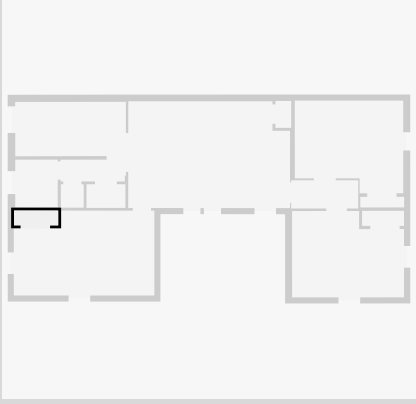

THIS FLOORPLAN IS PROVIDED WITHOUT WARRANTY OF ANY KIND. NAZCA PROPERTIES  
DISCLAIMS ANY WARRANTY INCLUDING, WITHOUT LIMITATION, SATISFACTORY QUALITY OR  
ACCURACY OF DIMENSIONS.

# Kitchen

Width: 10' 9 3/4"  
Length: 14' 11 1/4"  
Area: 136.49 sq ft  
Perimeter: 63' 9 3/4"

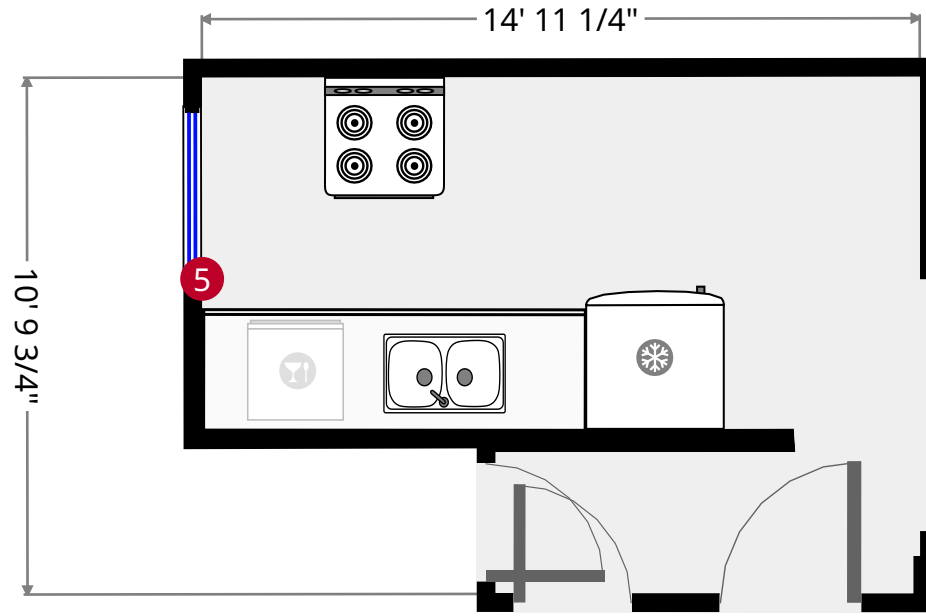
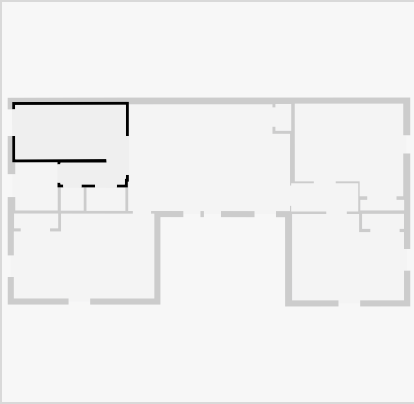

5



Hung Window

- Height: 6' 6"

THIS FLOORPLAN IS PROVIDED WITHOUT WARRANTY OF ANY KIND. NAZCA PROPERTIES  
DISCLAIMS ANY WARRANTY INCLUDING, WITHOUT LIMITATION, SATISFACTORY QUALITY OR  
ACCURACY OF DIMENSIONS.



## Utility

Width: 3' 2 1/4"  
Length: 5' 3"  
Area: 16.74 sq ft  
Perimeter: 16' 10 1/2"

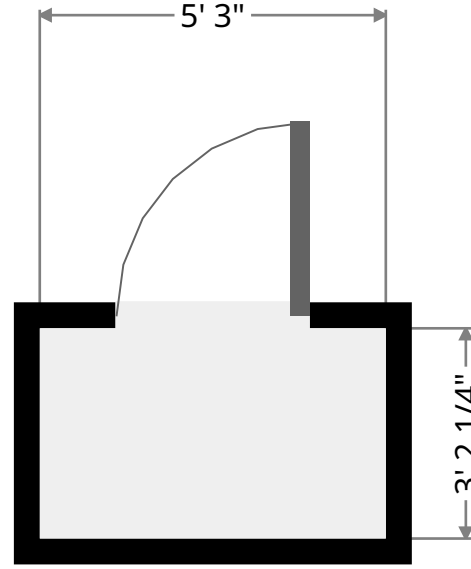
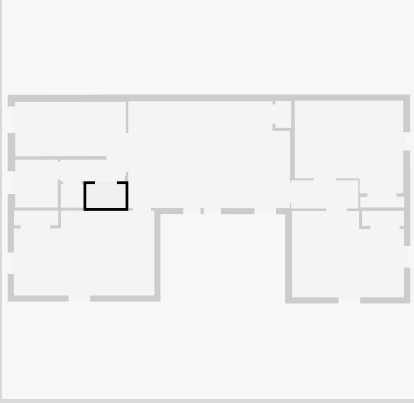

## Water Closet

Width: 3' 1"  
Length: 3' 2"  
Area: 9.75 sq ft  
Perimeter: 12' 6"

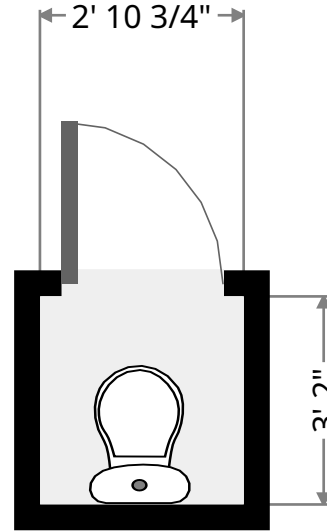
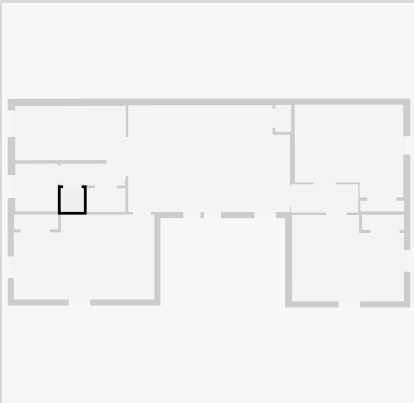

THIS FLOORPLAN IS PROVIDED WITHOUT WARRANTY OF ANY KIND. NAZCA PROPERTIES  
DISCLAIMS ANY WARRANTY INCLUDING, WITHOUT LIMITATION, SATISFACTORY QUALITY OR  
ACCURACY OF DIMENSIONS.



# Bathroom

Width: 5' 8 3/4"  
Length: 6' 5 1/4"  
Area: 36.98 sq ft  
Perimeter: 24' 4 1/2"

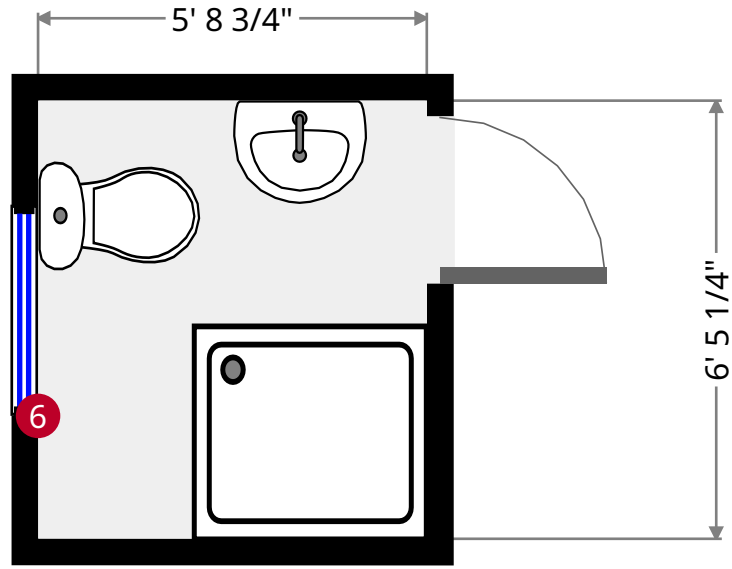
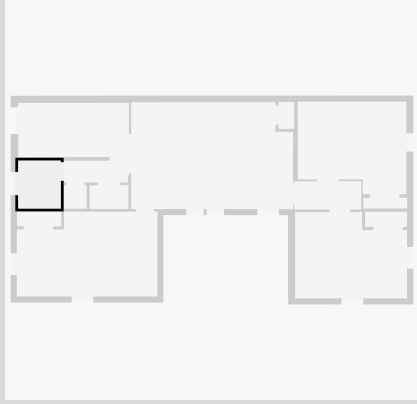

6



Hung Window

- Height: 6' 5 1/4"

THIS FLOORPLAN IS PROVIDED WITHOUT WARRANTY OF ANY KIND. NAZCA PROPERTIES  
DISCLAIMS ANY WARRANTY INCLUDING, WITHOUT LIMITATION, SATISFACTORY QUALITY OR  
ACCURACY OF DIMENSIONS.

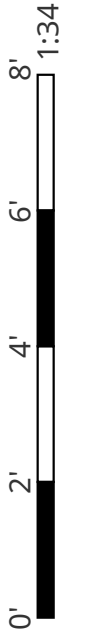



# Hall

Width: 3' 9 3/4"  
Length: 9' 1"  
Area: 34.44 sq ft  
Perimeter: 25' 8 1/2"

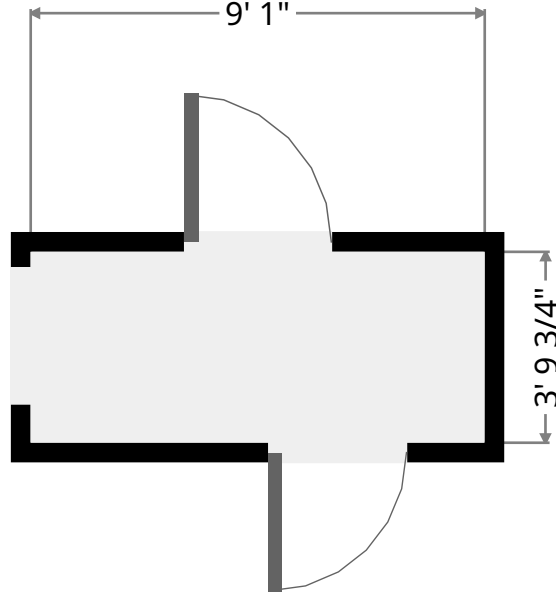
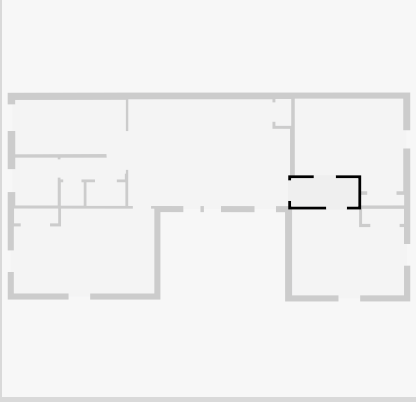

THIS FLOORPLAN IS PROVIDED WITHOUT WARRANTY OF ANY KIND. NAZCA PROPERTIES  
DISCLAIMS ANY WARRANTY INCLUDING, WITHOUT LIMITATION, SATISFACTORY QUALITY OR  
ACCURACY OF DIMENSIONS.

# Bedroom

Width: 11' 7 3/4"  
 Length: 15' 1 1/4"  
 Area: 161.22 sq ft  
 Perimeter: 53' 6 1/4"

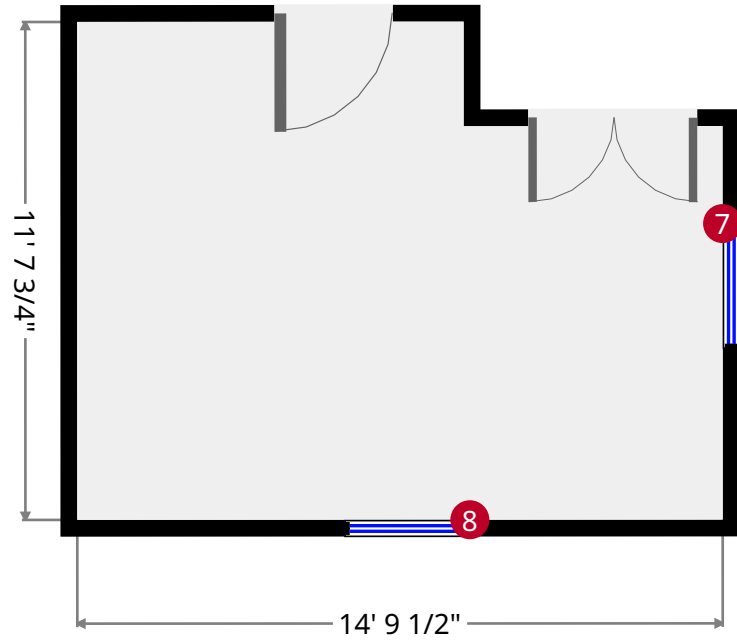
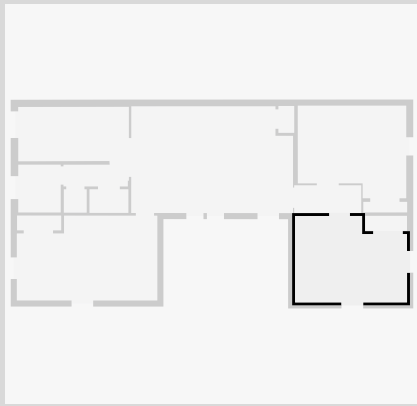

7



Hung Window

- Height: 5' 9 1/2"

8



Hung Window

- Height: 5' 9 1/2"

THIS FLOORPLAN IS PROVIDED WITHOUT WARRANTY OF ANY KIND. NAZCA PROPERTIES  
 DISCLAIMS ANY WARRANTY INCLUDING, WITHOUT LIMITATION, SATISFACTORY QUALITY OR  
 ACCURACY OF DIMENSIONS.

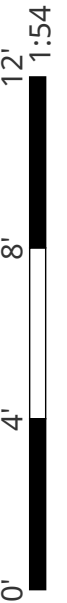

# Closet

Width: 2' 1/4"  
Length: 5' 7 3/4"  
Area: 11.51 sq ft  
Perimeter: 15' 4 1/2"

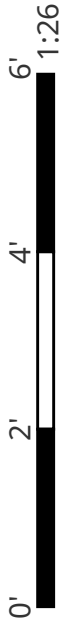
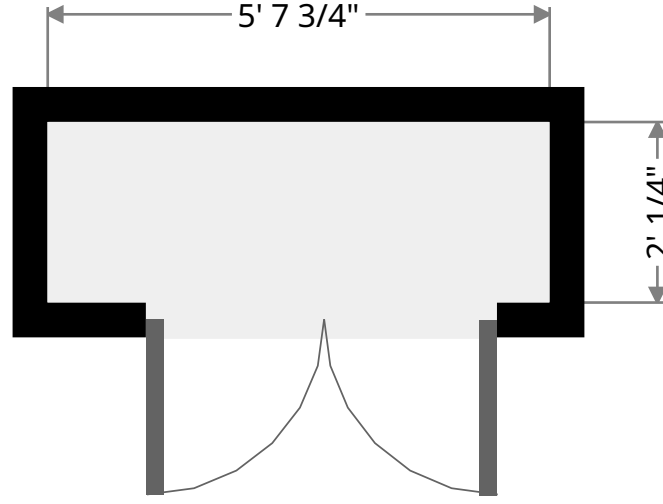
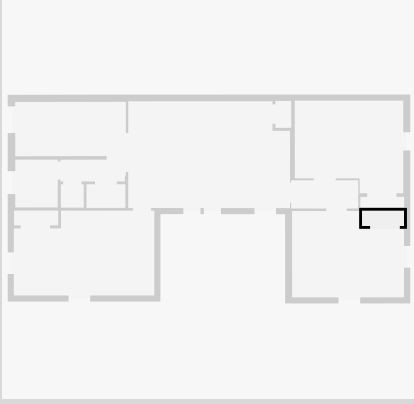

THIS FLOORPLAN IS PROVIDED WITHOUT WARRANTY OF ANY KIND. NAZCA PROPERTIES  
DISCLAIMS ANY WARRANTY INCLUDING, WITHOUT LIMITATION, SATISFACTORY QUALITY OR  
ACCURACY OF DIMENSIONS.

# Bedroom

Width: 12' 6 1/4"  
Length: 14' 8"  
Area: 165.43 sq ft  
Perimeter: 54' 3 1/2"

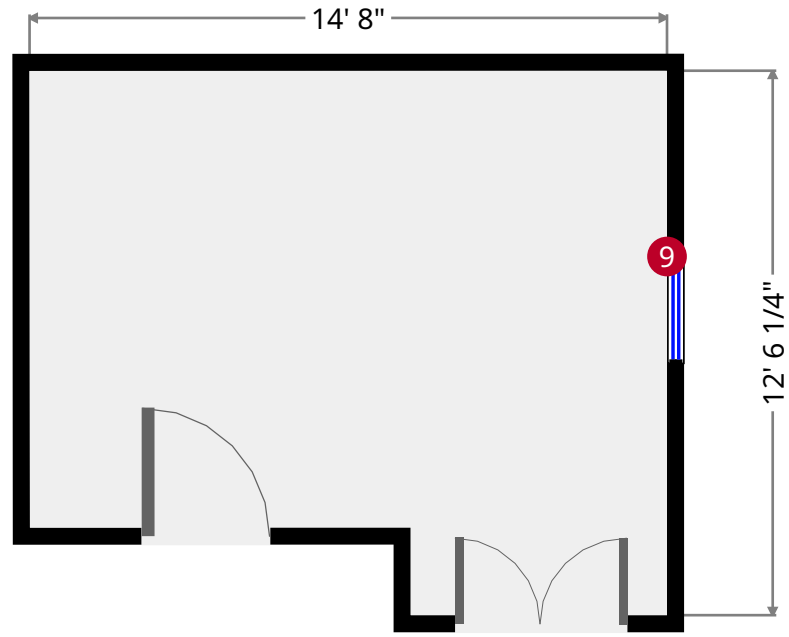
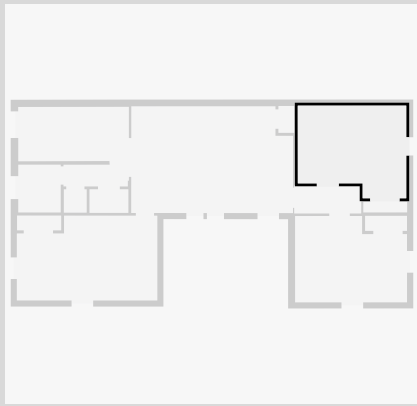

9



Hung Window

- Height: 6' 3 1/2"

THIS FLOORPLAN IS PROVIDED WITHOUT WARRANTY OF ANY KIND. NAZCA PROPERTIES  
DISCLAIMS ANY WARRANTY INCLUDING, WITHOUT LIMITATION, SATISFACTORY QUALITY OR  
ACCURACY OF DIMENSIONS.

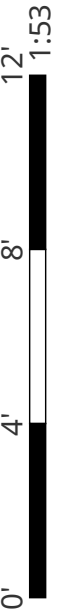

# Closet

Width: 1' 4 3/4"  
Length: 5' 11 1/4"  
Area: 8.48 sq ft  
Perimeter: 14' 8 1/2"

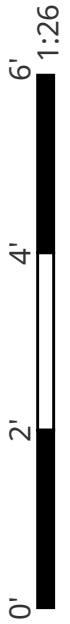
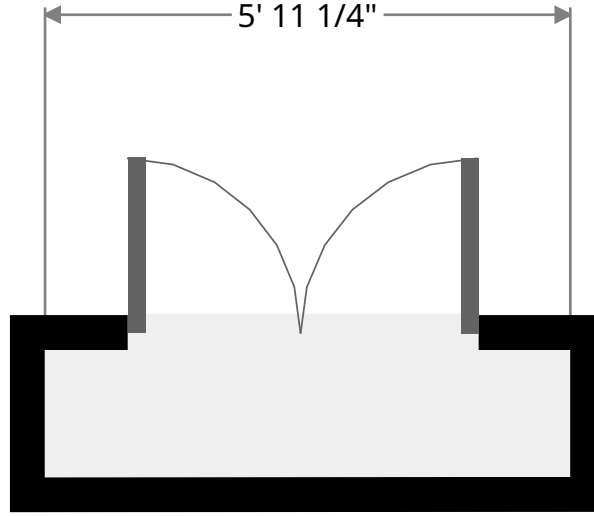
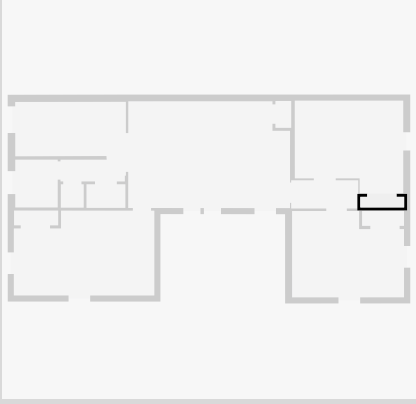

THIS FLOORPLAN IS PROVIDED WITHOUT WARRANTY OF ANY KIND. NAZCA PROPERTIES  
DISCLAIMS ANY WARRANTY INCLUDING, WITHOUT LIMITATION, SATISFACTORY QUALITY OR  
ACCURACY OF DIMENSIONS.