

29 W Daniels St. Apt. 16

1st Floor



Nazca Properties
manager@nazcaproperties.com
513-535-2154

Statistics

Area: 600 sq ft
1 Floor
1 Bedroom
1 Bathroom

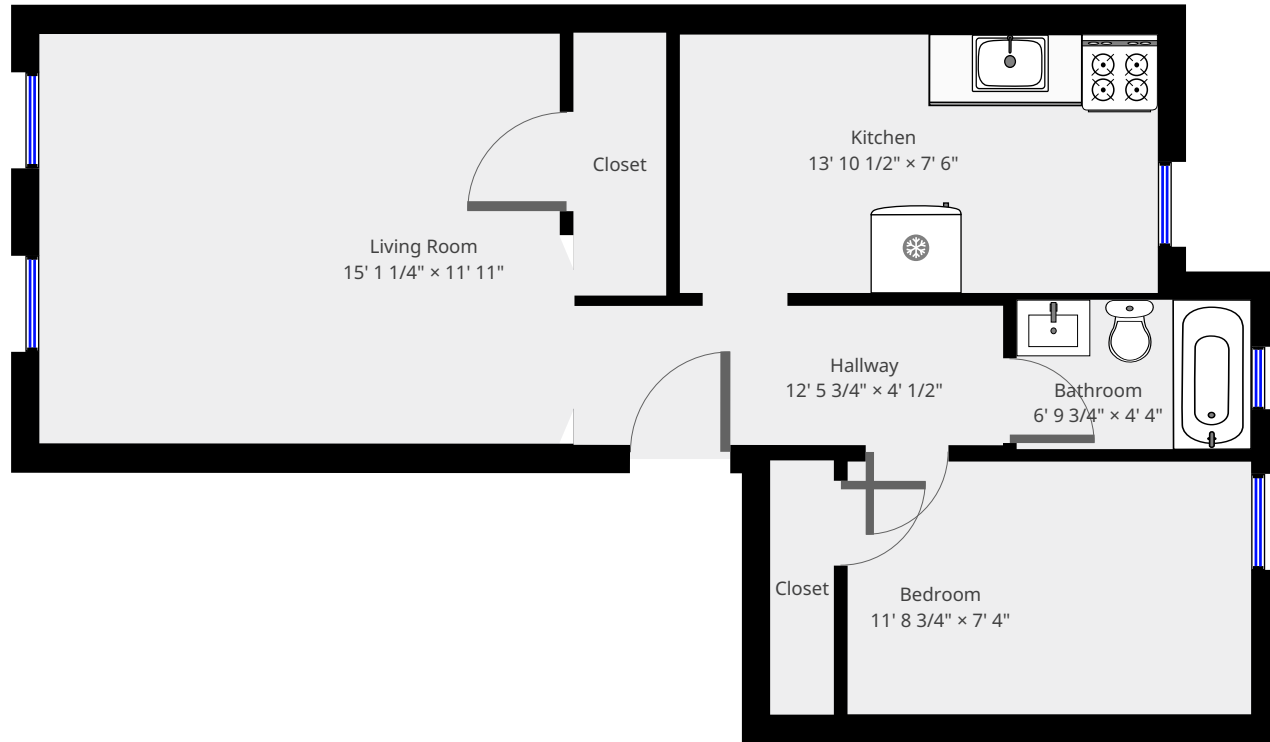

THIS FLOORPLAN IS PROVIDED WITHOUT WARRANTY OF ANY KIND. NAZCA PROPERTIES
DISCLAIMS ANY WARRANTY INCLUDING, WITHOUT LIMITATION, SATISFACTORY QUALITY OR
ACCURACY OF DIMENSIONS.



Hallway

Width: 4' 1/2"
Length: 12' 5 3/4"
Area: 50.43 sq ft
Perimeter: 33' 1/2"
Ceiling Height: 8' 3/4"

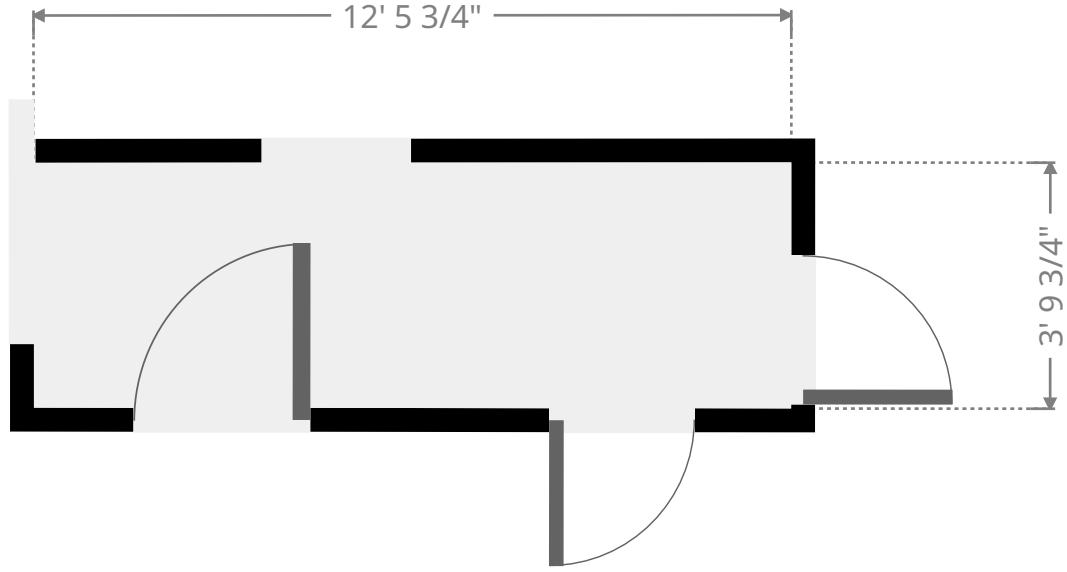
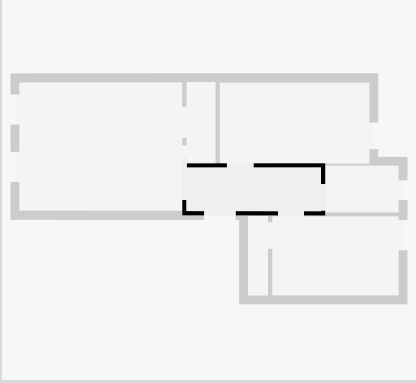

THIS FLOORPLAN IS PROVIDED WITHOUT WARRANTY OF ANY KIND. NAZCA PROPERTIES
DISCLAIMS ANY WARRANTY INCLUDING, WITHOUT LIMITATION, SATISFACTORY QUALITY OR
ACCURACY OF DIMENSIONS.

Living Room

Width: 11' 11"
Length: 15' 1 1/4"
Area: 179.82 sq ft
Perimeter: 54' 1/4"
Ceiling Height: 8' 3/4"

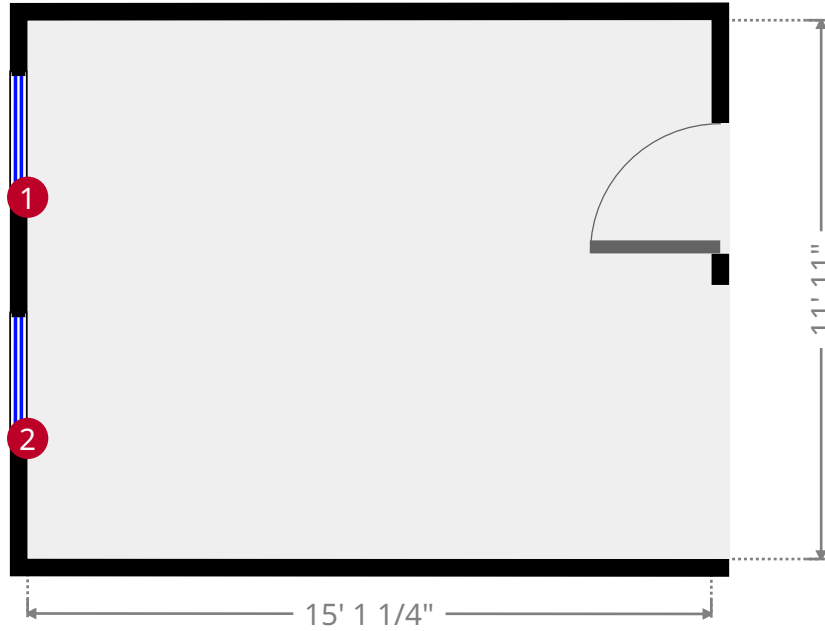
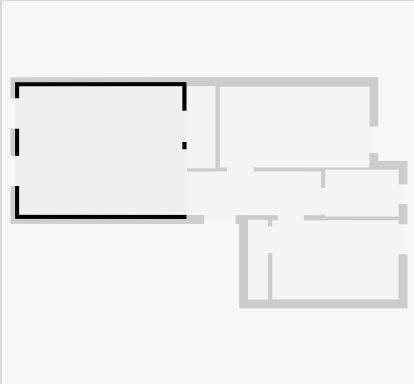

1



Hung Window

- Height: 5' 4 3/4"

2



Hung Window

- Height: 5' 4 3/4"

THIS FLOORPLAN IS PROVIDED WITHOUT WARRANTY OF ANY KIND. NAZCA PROPERTIES
DISCLAIMS ANY WARRANTY INCLUDING, WITHOUT LIMITATION, SATISFACTORY QUALITY OR
ACCURACY OF DIMENSIONS.

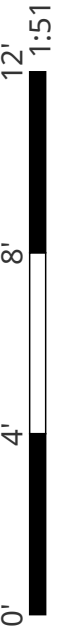

Closet

Width: 2' 8 1/4"
Length: 7' 7 3/4"
Area: 20.60 sq ft
Perimeter: 20' 8"
Ceiling Height: 8' 3/4"

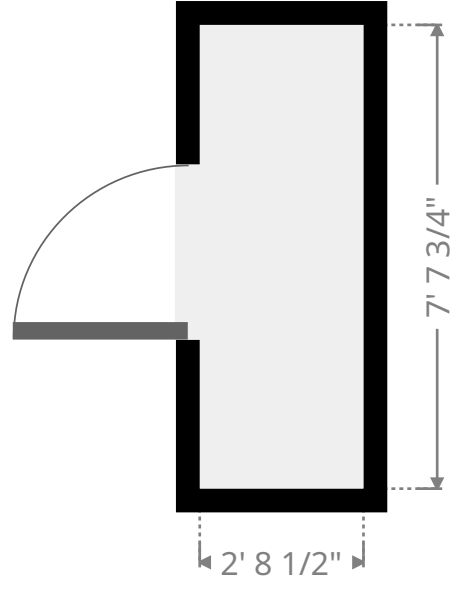
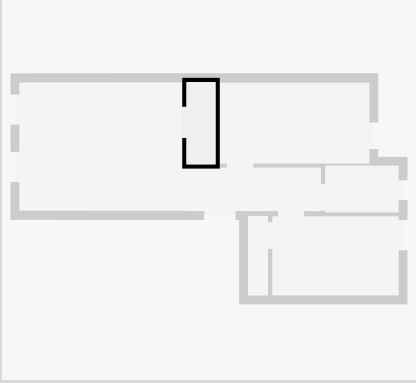

THIS FLOORPLAN IS PROVIDED WITHOUT WARRANTY OF ANY KIND. NAZCA PROPERTIES
DISCLAIMS ANY WARRANTY INCLUDING, WITHOUT LIMITATION, SATISFACTORY QUALITY OR
ACCURACY OF DIMENSIONS.

Kitchen

Width: 7' 6"
Length: 13' 10 1/2"
Area: 104.18 sq ft
Perimeter: 42' 9 1/4"
Ceiling Height: 8' 3/4"

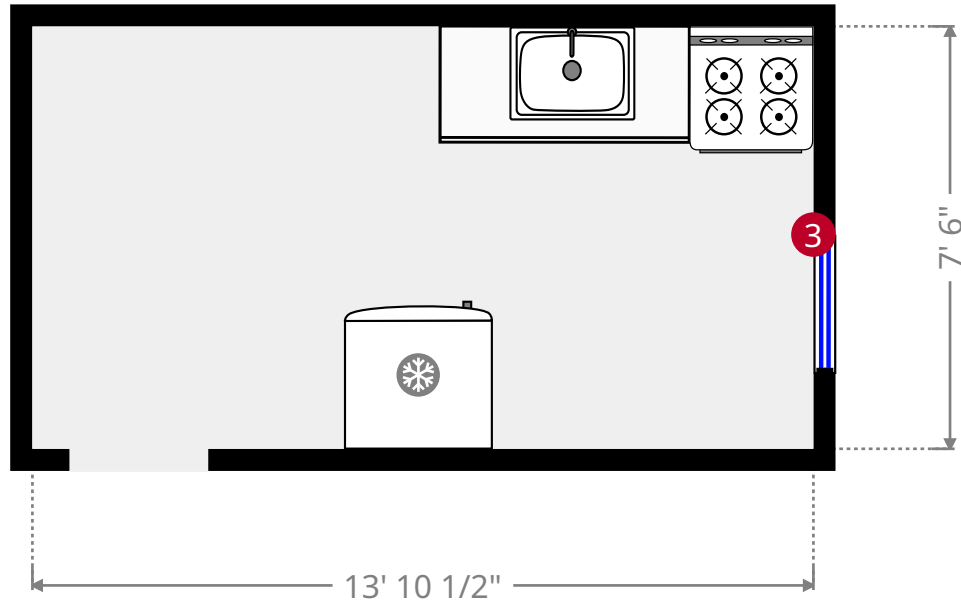
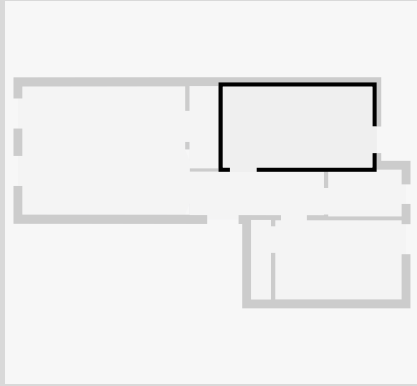

3



Hung Window

- Height: 5' 6 1/2"



THIS FLOORPLAN IS PROVIDED WITHOUT WARRANTY OF ANY KIND. NAZCA PROPERTIES
DISCLAIMS ANY WARRANTY INCLUDING, WITHOUT LIMITATION, SATISFACTORY QUALITY OR
ACCURACY OF DIMENSIONS.

Bathroom

Width: 4' 4"
Length: 6' 9 3/4"
Area: 29.54 sq ft
Perimeter: 22' 3 1/2"
Ceiling Height: 8' 3/4"

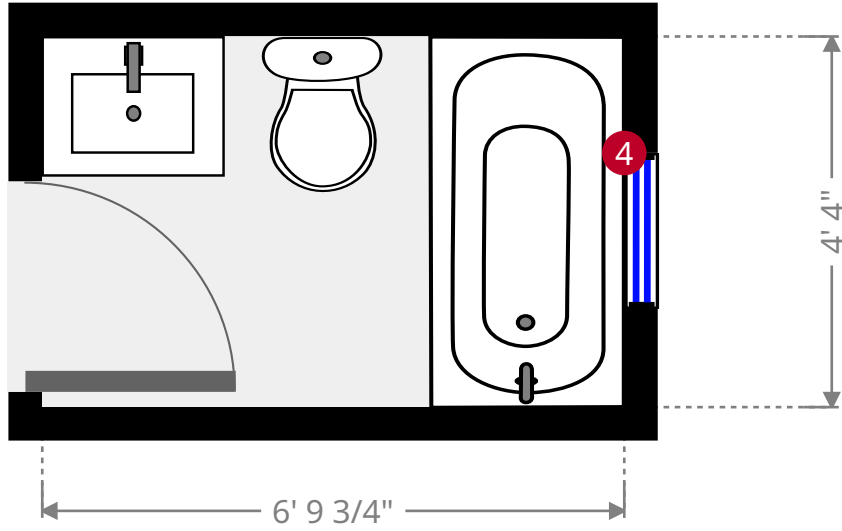
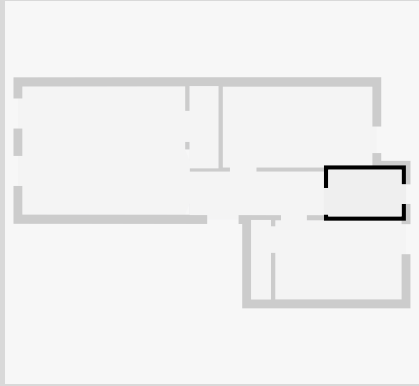

4



Hung Window

- Height: 3' 9 1/4"

THIS FLOORPLAN IS PROVIDED WITHOUT WARRANTY OF ANY KIND. NAZCA PROPERTIES
DISCLAIMS ANY WARRANTY INCLUDING, WITHOUT LIMITATION, SATISFACTORY QUALITY OR
ACCURACY OF DIMENSIONS.

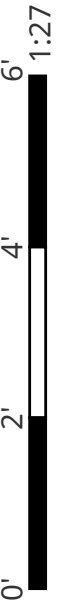

Bedroom

Width: 7' 4"
Length: 11' 8 3/4"
Area: 85.98 sq ft
Perimeter: 38' 1 1/4"
Ceiling Height: 8' 3/4"

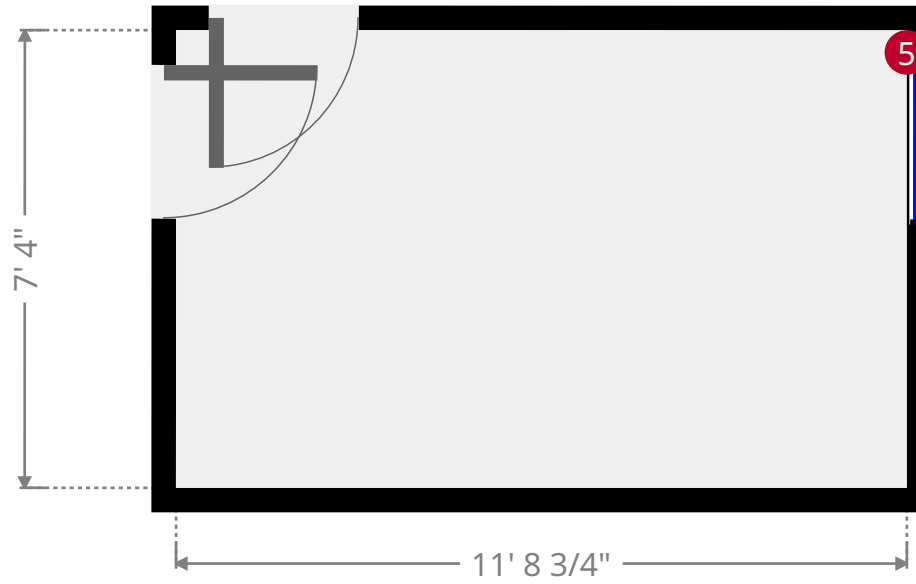
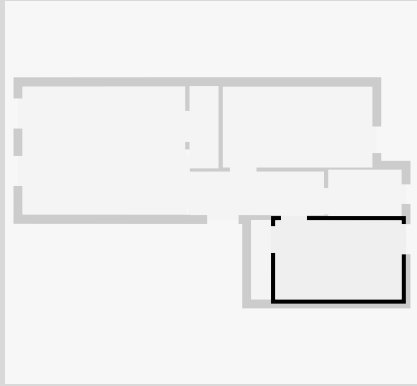

5



Hung Window

- Height: 5' 4 3/4"

THIS FLOORPLAN IS PROVIDED WITHOUT WARRANTY OF ANY KIND. NAZCA PROPERTIES
DISCLAIMS ANY WARRANTY INCLUDING, WITHOUT LIMITATION, SATISFACTORY QUALITY OR
ACCURACY OF DIMENSIONS.



Closet

Width: 1' 10 1/4"
Length: 7' 4 1/2"
Area: 13.66 sq ft
Perimeter: 18' 5 1/2"
Ceiling Height: 8' 3/4"

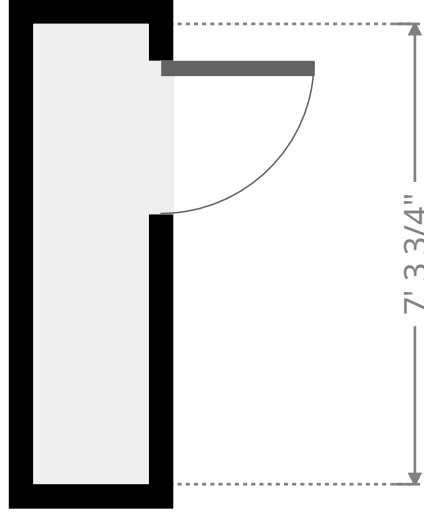
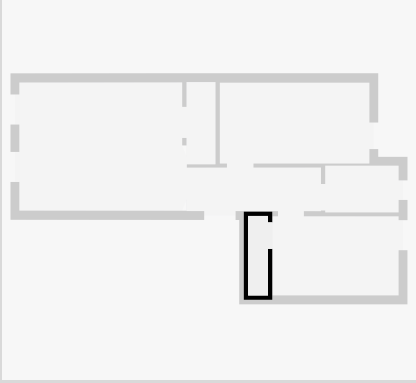

THIS FLOORPLAN IS PROVIDED WITHOUT WARRANTY OF ANY KIND. NAZCA PROPERTIES
DISCLAIMS ANY WARRANTY INCLUDING, WITHOUT LIMITATION, SATISFACTORY QUALITY OR
ACCURACY OF DIMENSIONS.